



VÝROBA NEREZOVÉHO ZAŘÍZENÍ POTRAVINÁŘSKÝCH PROVOZŮ



PRACOVNÍ DESKY

1/PD1



2/PD2



3/PD3



4/PD4



5/KPD



PRACOVNÍ STOLY

6/ST



7/ST1



8/SP



9/SP1



10/SPP



11/SPP1



12/SPU



13/SPU1



14/SPPU



15/SPPU1



16/SPUPD



17/SPUPD1



18/SPPUPD



19/SPPUPD1



20/SPUKD



21/SPUKD1

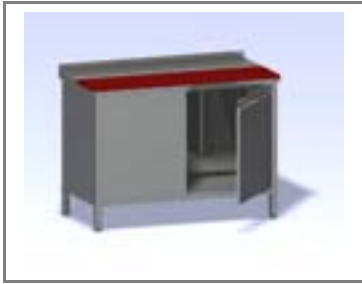

22/SPPUKD

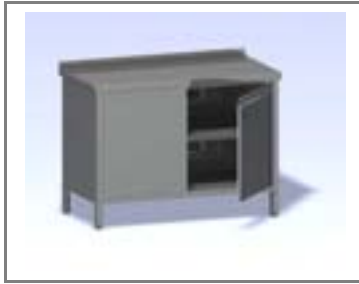

23/SPPUKD1



24/SZHT



25/SZHT1



26/SSZHP



27/SZHP1



28/SZB



29/SZB1



30/SZBP



31/SZBP1



32/SZBUP-PD



33/SZBUP-PD1



34/SZBUPP-PD



35/SZBUPP-PD1



36/SZBUP-KD



37/SZBUP-KD1



38/SZBUPP-KD



39/SZBUPP-KD1



40/SPGN



41/SPGN1



42/SPUGN



43/SPUGN1



44/SZB2



45/SZB3



MYCÍ STOLY - JEDNODŘEZOVÉ

46/SMD



47/SMDP



48/SMDR



49/SMDZ



50/SMDZP



51/SMDZR



52/SMDZB



53/SMDZBP



54/SMDZBR



55/SMDUP-PD



56/SMDUZBP-PD



57/SMDUZBP-KD



MYCÍ STOLY - DVOUŘEZOVÉ

58/SMDV



59/SMDVP



60/SMDVR



61/SMDVZ-2



62/SMDVZP-2



63/SMDVZR-2



64/SMDVUZB-2



65/SMDVUZBP-2



66/SMDVUZBR-2



67/SMDVUZBP-PD



68/SMDVUP-PD



VSTUPNÍ STOLY K MYČKÁM

69/VSM1



70/Z1



VÝSTUPNÍ STOLY K MYČKÁM

71/VSM2



72/Z2



DŘEZY

73/D



74/DP



75/DR



76/DV



77/DVP



78/DVR



DŘEZY SVAŘOVANÉ

79/DS



80/DSP



81/DSR



82/DVS



83/DVSP



84/DVSR



85/DS-V



86/DSP-V



87/DVSR-V



VÝLEVKY

88/VKU20



89/VKU21



NÁSTĚNNÉ POLICE

90/NP1

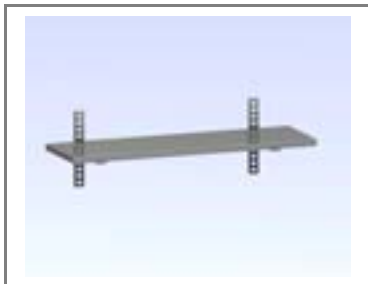

91/NP2



92/NP3



STOJANOVÉ POLICE

93/SP1



94/SP2



95/SPU1



96/SPU2



NÁSTĚNNÉ SKŘÍŇKY

97/SNP

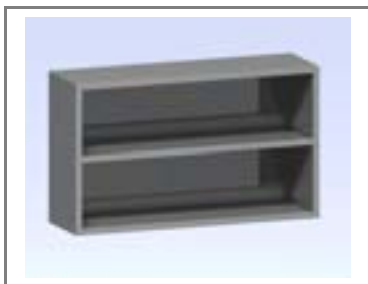

98/SNP-PD



99/SNP-KD

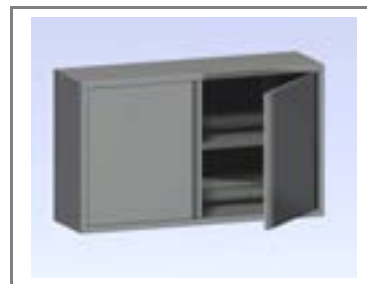

SKŘÍŇOVÝ PŘÍBORNÍK

100/USP-PD



101/USP-KD



VOZÍKY

102/VPP56



103/VMZO



104/VOS1



105/VOS2



106/VOP



107/VMGN



108/GN1/1, GN 1/2

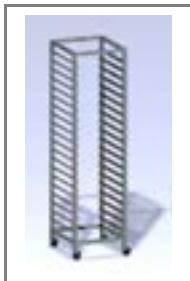

PODESTAVBY

109/PK



110/PK1



111/PK2-P



112/PK3-P



REGÁLY

113/RP4/RP5



114/RR4/RR5



115/RGN



NÁSTĚNNÉ OSDSAVAČE PAR

116/NOP-1



117/NOP-2



ZÁVĚSNÉ OSDSAVAČE PAR

118/ZOP-1



119/ZOP-2



POJEZDY

120/DPT



121/DPJ__



ZÁSObNÍKY

122/ZGN-U



123/ZGN-O__



PODLAHOVÝ ROŠT S VPUSTÍ

124/PRV

VAR1



VAR2



VAR3__



VÝČEPNÍ DESKA

125/VD

VAR1

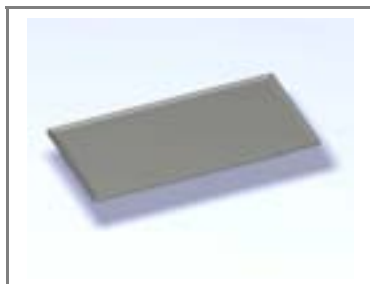

VAR2

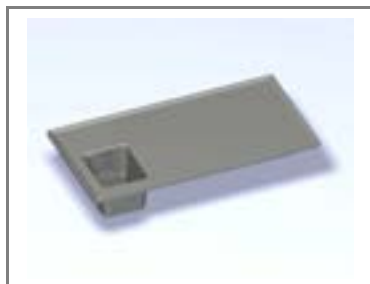

VAR3

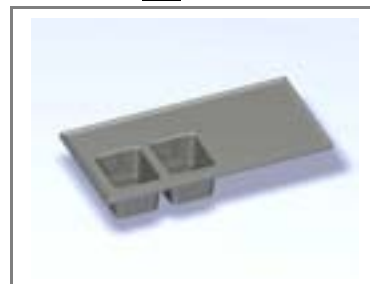

VAR4



VAR5



VEVAŘENÍ DŘEZŮ

126/VEVAŘENÍ DŘEZŮ

340x400x250



400x400x250



400x500x250



450x4450x250



420x220x330 (SVAŘOVANÝ DŘEZ)



VEVAŘENÍ GN DŘEZŮ A ODKAPŮ

127/ DŘEZY A ODKAPY
GN 2/3-200

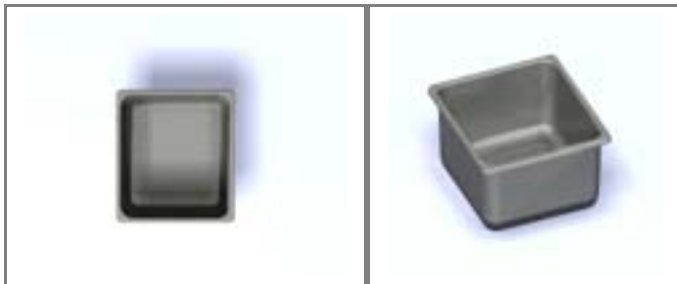

GN 1/2-200



ODKAP-8

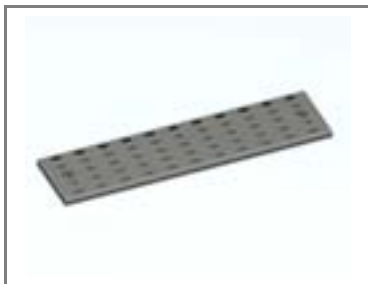

ODKAP-6



ODKAP-4



PŘENOSNÉ ODKAPY

128/ PŘENOSNÉ ODKAPY
ODKAP-P/8



ODKAP-P/6



ODKAP-P/4



STŮL CHLADÍCÍ

129/DVOUDVĚŘOVÝ



130/TŘÍDVĚŘOVÝ



131/ČTYŘDVĚŘOVÝ



PŘÍSLUŠENSTVÍ

DESKA HORNÍ S LEMEM



DESKA HORNÍ GRANITOVÁ



ZÁSUVKOVÝ SET

2 x ZÁSUVKA (1/2+1/2)



2 x ZÁSUVKA (1/3+2/3)



3 x ZÁSUVKA (1/3+1/3+1/3)



ZAMYKÁNÍ CHLAZENÉHO STOLU

PD1

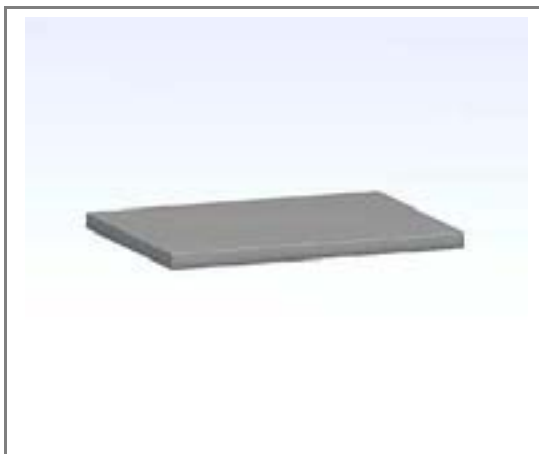

PRACOVNÍ DESKA ROVNÁ				
A - délka	B - šířka (mm)			
(mm)	500	600	700	800
400	1 250,-	1 360,-	1 480,-	1 570,-
500	1 350,-	1 520,-	1 660,-	1 770,-
600	1 500,-	1 690,-	1 840,-	1 970,-
700	1 630,-	1 840,-	2 020,-	2 170,-
800	1 760,-	2 000,-	2 200,-	2 370,-
900	1 890,-	2 170,-	2 380,-	2 570,-
1000	2 020,-	2 320,-	2 560,-	2 770,-
1100	2 150,-	2 480,-	2 740,-	2 970,-
1200	2 280,-	2 640,-	2 920,-	3 170,-
1300	2 410,-	2 800,-	3 100,-	3 370,-
1400	2 540,-	2 960,-	3 280,-	3 570,-
1500	2 670,-	3 120,-	3 460,-	3 770,-
1600	2 800,-	3 280,-	3 640,-	3 970,-
1700	2 930,-	3 440,-	3 820,-	4 170,-
1800	3 060,-	3 600,-	4 010,-	4 370,-
1900	3 190,-	3 760,-	4 180,-	4 570,-
2000	3 320,-	3 920,-	4 360,-	4 770,-
2100	3 350,-	4 080,-	4 540,-	5 970,-
2200	3 590,-	4 240,-	4 720,-	5 170,-
2300	3 710,-	4 400,-	4 910,-	5 370,-
2400	3 840,-	4 560,-	5 080,-	5 570,-
2500	3 970,-	4 720,-	5 260,-	5 770,-
2600	4 100,-	4 880,-	5 440,-	5 970,-
2700	4 230,-	5 040,-	5 620,-	6 170,-
2800	4 430,-	5 130,-	5 750,-	6 370,-

Příplatek za atypické provedení

Boční úkos: 20%

PD2

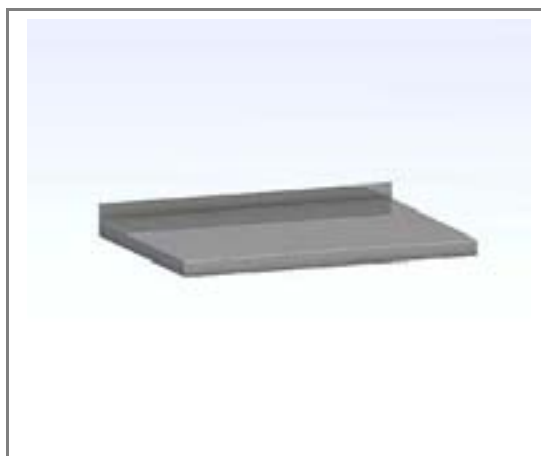

PRACOVNÍ DESKA SE ZADNÍM ZVÝŠENÝM LEMEM				
A - délka	B - šířka (mm)			
(mm)	500	600	700	800
400	1 630,-	1 750,-	1 880,-	1 980,-
500	1 780,-	1 920,-	2 070,-	2 200,-
600	1 930,-	2 090,-	2 260,-	2 420,-
700	2 080,-	2 260,-	2 450,-	2 640,-
800	2 230,-	2 430,-	2 640,-	2 860,-
900	2 380,-	2 600,-	2 830,-	3 080,-
1000	2 530,-	2 770,-	3 020,-	3 300,-
1100	2 680,-	2 940,-	3 210,-	3 520,-
1200	2 830,-	3 110,-	3 400,-	3 740,-
1300	2 980,-	3 290,-	3 590,-	3 960,-
1400	3 130,-	3 450,-	3 780,-	4 180,-
1500	3 280,-	3 620,-	3 970,-	4 400,-
1600	3 430,-	3 790,-	4 160,-	4 620,-
1700	3 580,-	3 960,-	4 350,-	4 840,-
1800	3 730,-	4 130,-	4 540,-	5 060,-
1900	3 880,-	4 300,-	4 730,-	5 280,-
2000	4 030,-	4 470,-	4 920,-	5 500,-
2100	4 180,-	4 640,-	5 110,-	5 720,-
2200	4 330,-	4 810,-	5 300,-	5 940,-
2300	4 480,-	4 980,-	5 490,-	6 160,-
2400	4 630,-	5 150,-	5 680,-	6 380,-
2500	4 780,-	5 320,-	5 870,-	6 600,-
2600	4 930,-	5 490,-	6 060,-	6 820,-
2700	5 080,-	5 660,-	6 250,-	7 040,-
2800	5 200,-	5 830,-	6 440,-	7 260,-

Příplatek za atypické provedení

Boční úkos: 20%

PD3



MASODESKA - 20mm				
A - délka	B - šířka (mm)			
(mm)	500	600	700	800
400	900,-	1 080,-	1 260,-	1 440,-
500	1 125,-	1 350,-	1 575,-	1 800,-
600	1 350,-	1 620,-	1 890,-	2 160,-
700	1 575,-	1 890,-	2 205,-	2 520,-
800	1 800,-	2 160,-	2 520,-	2 880,-
900	2 025,-	2 430,-	2 835,-	3 240,-
1000	2 250,-	2 700,-	3 150,-	3 600,-
1100	2 475,-	2 970,-	3 465,-	3 960,-
1200	2 700,-	3 240,-	3 780,-	4 320,-
1300	2 925,-	3 510,-	4 095,-	4 680,-
1400	3 150,-	3 780,-	4 410,-	5 040,-
1500	3 375,-	4 050,-	4 725,-	5 400,-
1600	3 600,-	4 320,-	5 040,-	5 760,-
1700	3 825,-	4 590,-	5 355,-	6 120,-
1800	4 050,-	4 860,-	5 670,-	6 480,-
1900	4 275,-	5 130,-	5 985,-	6 840,-
2000	4 500,-	5 400,-	6 300,-	7 200,-

Příplatek za atypické provedení

Boční úkos: 20%

PD4



MASODESKA - 60mm				
A - délka	B - šířka (mm)			
(mm)	500	600	700	800
400	3 000,-	3 600,-	4 200,-	4 800,-
500	3 750,-	4 500,-	5 250,-	6 000,-
600	4 500,-	5 400,-	6 300,-	7 200,-
700	5 250,-	6 300,-	7 350,-	8 400,-
800	6 000,-	7 200,-	8 400,-	9 600,-

Příplatek za atypické provedení

Boční úkos: 20%



KONZOLE POD PRACOVNÍ DESKOU			
Pro šířku desky			
500	600	700	800
900,-	1 000,-	1 100,-	1 200,-



STŮL PRACOVNÍ S TRNOŽÍ			
A - délka	B - šířka (mm)		
(mm)	600	700	800
500	5 640,-	5 800,-	6 210,-
600	5 970,-	6 140,-	6 550,-
700	6 300,-	6 480,-	6 890,-
800	6 630,-	6 820,-	7 230,-
900	6 960,-	7 160,-	7 570,-
1000	7 290,-	7 500,-	7 910,-
1100	7 620,-	7 840,-	8 250,-
1200	7 950,-	8 180,-	8 590,-
1300	8 280,-	8 520,-	8 930,-
1400	8 610,-	8 860,-	9 270,-
1500	8 940,-	9 200,-	9 610,-
1600	9 270,-	9 540,-	9 950,-
1700	9 600,-	9 880,-	10 290,-
1800	9 930,-	10 220,-	10 630,-
1900	10 260,-	10 560,-	10 970,-
2000	10 590,-	10 900,-	11 310,-

Příplatek za atypické provedení

Boční úkos horní desky: 900,-

Otvor v horní desce: 1800,-

Pojízdné provedení: 2400,-

ST1



STŮL PRACOVNÍ S TRNOŽÍ A POLOVIČNÍ ŘEZNOU DESKOU			
A - délka	B - šířka (mm)		
(mm)	600	700	800
500	7 380,-	7 640,-	8 150,-
600	7 680,-	8 040,-	8 650,-
700	7 980,-	8 440,-	9 150,-
800	8 280,-	8 840,-	9 650,-
900	8 580,-	9 240,-	10 150,-
1000	8 880,-	9 640,-	10 650,-
1100	9 180,-	10 040,-	11 150,-
1200	9 480,-	10 440,-	11 650,-
1300	9 780,-	10 840,-	12 150,-
1400	10 080,-	11 240,-	12 650,-
1500	10 380,-	11 640,-	13 150,-
1600	10 680,-	12 040,-	13 650,-
1700	10 980,-	12 440,-	14 150,-
1800	11 280,-	12 840,-	14 650,-
1900	11 580,-	13 240,-	15 150,-
2000	11 880,-	13 640,-	15 650,-

Příplatek za atypické provedení

Boční úkos horní desky: 900,-

Otvor v horní desce: 1800,-

Pojízdné provedení: 2400,-



STŮL PRACOVNÍ S POLICÍ			
A - délka	B - šířka (mm)		
(mm)	600	700	800
500	6 780,-	7 140,-	7 760,-
600	7 200,-	7 560,-	8 190,-
700	7 620,-	7 980,-	8 620,-
800	8 040,-	8 400,-	9 050,-
900	8 460,-	8 820,-	9 480,-
1000	8 880,-	9 240,-	9 910,-
1100	9 300,-	9 660,-	10 340,-
1200	9 720,-	10 080,-	10 770,-
1300	10 140,-	10 500,-	11 200,-
1400	10 560,-	10 920,-	11 630,-
1500	10 980,-	11 340,-	12 060,-
1600	11 400,-	11 760,-	12 490,-
1700	11 820,-	12 180,-	12 920,-
1800	12 240,-	12 600,-	13 350,-
1900	12 660,-	13 020,-	13 780,-
2000	13 080,-	13 440,-	14 210,-

Příplatek za atypické provedení

Boční úkos horní desky: 900,-

Otvor v horní desce: 1800,-

Pojízdné provedení: 2400,-

SP1



STŮL PRACOVNÍ S POLICÍ A POLOVIČNÍ ŘEZNOU DESKOU			
A - délka	B - šířka (mm)		
(mm)	600	700	800
600	9 160,-	9 600,-	10 330,-
700	9 680,-	10 120,-	10 870,-
800	10 200,-	10 640,-	11 410,-
900	10 720,-	11 160,-	11 950,-
1000	11 240,-	11 680,-	12 490,-
1100	11 760,-	12 100,-	13 030,-
1200	12 280,-	12 720,-	13 570,-
1300	12 700,-	13 140,-	14 110,-
1400	13 320,-	13 760,-	14 650,-
1500	13 740,-	14 180,-	15 190,-
1600	14 360,-	14 800,-	15 730,-
1700	14 780,-	15 320,-	16 170,-
1800	15 400,-	15 840,-	16 810,-
1900	15 920,-	16 360,-	17 350,-
2000	16 370,-	16 940,-	17 850,-

Příplatek za atypické provedení

Boční úkos horní desky: 900,-

Otvor v horní desce: 1800,-

Pojízdné provedení: 2400,-



STŮL PRACOVNÍ S DVĚMA POLICEMI			
A - délka	B - šířka (mm)		
(mm)	600	700	800
500	8 350,-	9 150,-	9 550,-
600	8 920,-	9 720,-	10 150,-
700	9 490,-	10 290,-	10 750,-
800	10 060,-	10 860,-	11 350,-
900	10 630,-	11 430,-	11 950,-
1000	11 200,-	12 000,-	12 550,-
1100	11 770,-	12 570,-	13 150,-
1200	12 340,-	13 140,-	13 750,-
1300	12 910,-	13 710,-	14 350,-
1400	13 480,-	14 280,-	14 950,-
1500	14 050,-	14 850,-	15 550,-
1600	14 620,-	15 420,-	16 150,-
1700	15 190,-	15 990,-	16 750,-
1800	15 760,-	16 560,-	17 350,-
1900	16 330,-	17 130,-	17 950,-
2000	16 900,-	17 700,-	18 550,-

Příplatek za atypické provedení

Boční úkos horní desky: 900,-

Otvor v horní desce: 1800,-

Pojízdné provedení: 2400,-

SPP1



STŮL PRACOVNÍ S DVĚMA POLICEMI A POLOVIČNÍ ŘEZNOU DESKOU			
A - délka	B - šířka (mm)		
(mm)	600	700	800
500	10 310,-	11 110,-	11 510,-
600	10 880,-	11 680,-	12 110,-
700	11 450,-	12 250,-	12 710,-
800	12 020,-	12 820,-	13 310,-
900	12 590,-	13 390,-	13 910,-
1000	13 160,-	13 960,-	14 510,-
1100	13 730,-	14 530,-	15 110,-
1200	14 300,-	15 100,-	15 710,-
1300	14 870,-	15 670,-	16 310,-
1400	15 440,-	16 240,-	16 910,-
1500	16 010,-	16 810,-	17 510,-
1600	16 580,-	17 380,-	18 110,-
1700	17 150,-	17 950,-	18 710,-
1800	17 720,-	18 520,-	19 310,-
1900	18 290,-	19 090,-	19 910,-
2000	18 860,-	19 660,-	20 510,-

Příplatek za atypické provedení

Boční úkos horní desky: 900,-

Otvor v horní desce: 1800,-

Pojízdné provedení: 2400,-



STŮL PRACOVNÍ S POLICÍ, OPLÁŠTĚNÝ			
A - délka	B - šířka (mm)		
(mm)	600	700	800
500	10 180,-	10 900,-	11 520,-
600	10 520,-	11 250,-	11 900,-
700	10 860,-	11 600,-	12 280,-
800	11 200,-	11 950,-	12 660,-
900	11 540,-	12 300,-	13 040,-
1000	11 880,-	12 650,-	13 420,-
1100	12 220,-	13 000,-	13 800,-
1200	12 560,-	13 350,-	14 180,-
1300	12 900,-	13 700,-	14 560,-
1400	13 240,-	14 050,-	14 940,-
1500	13 580,-	14 400,-	15 320,-
1600	13 920,-	14 750,-	15 700,-
1700	14 260,-	15 100,-	16 080,-
1800	14 600,-	15 450,-	16 460,-
1900	14 940,-	15 800,-	16 840,-
2000	15 280,-	16 150,-	17 220,-

Příplatek za atypické provedení

Boční úkos horní desky: 900,-

Otvor v horní desce: 1800,-

Pojízdné provedení: 2400,-

SPU1



STŮL PRACOVNÍ S POLICÍ, OPLÁŠTĚNÝ A POLOVIČNÍ ŘEZNOU DESKOU			
A - délka	B - šířka (mm)		
(mm)	600	700	800
500	12 140,-	12 860,-	13 480,-
600	12 480,-	13 210,-	13 860,-
700	12 820,-	13 560,-	14 240,-
800	13 160,-	13 910,-	14 620,-
900	13 500,-	14 260,-	15 000,-
1000	13 840,-	14 610,-	15 380,-
1100	14 180,-	14 960,-	15 760,-
1200	14 520,-	15 310,-	16 140,-
1300	14 860,-	15 660,-	16 520,-
1400	15 200,-	16 010,-	16 900,-
1500	15 540,-	16 360,-	17 280,-
1600	15 880,-	16 710,-	17 660,-
1700	16 220,-	17 060,-	18 040,-
1800	16 560,-	17 410,-	18 420,-
1900	16 900,-	17 760,-	18 800,-
2000	17 240,-	18 110,-	19 180,-

Příplatek za atypické provedení

Boční úkos horní desky: 900,-

Otvor v horní desce: 1800,-

Pojízdné provedení: 2400,-



STŮL PRACOVNÍ S DVĚMA POLICEMI, OPLÁŠTĚNÝ			
A - délka	B - šířka (mm)		
(mm)	600	700	800
500	11 750,-	12 550,-	12 950,-
600	12 320,-	13 120,-	13 550,-
700	12 890,-	13 690,-	14 150,-
800	13 460,-	14 260,-	14 750,-
900	14 030,-	14 830,-	15 350,-
1000	14 600,-	15 400,-	15 950,-
1100	15 170,-	15 970,-	16 550,-
1200	15 740,-	16 540,-	17 150,-
1300	16 310,-	17 110,-	17 750,-
1400	16 880,-	17 680,-	18 350,-
1500	17 450,-	18 250,-	18 950,-
1600	18 020,-	18 820,-	19 550,-
1700	18 590,-	19 390,-	20 150,-
1800	19 160,-	19 960,-	20 750,-
1900	19 730,-	20 530,-	21 350,-
2000	20 300,-	21 100,-	21 950,-

Příplatek za atypické provedení

Boční úkos horní desky: 900,-

Otvor v horní desce: 1800,-

Pojízdné provedení: 2400,-

SPPU1



STŮL PRACOVNÍ S DVĚMA POLICEMI, OPLÁŠTĚNÝ A POLOVIČNÍ ŘEZNOU DESKOU			
A - délka	B - šířka (mm)		
(mm)	600	700	800
500	13 710,-	14 510,-	14 910,-
600	14 280,-	15 080,-	15 510,-
700	14 850,-	15 650,-	16 110,-
800	15 420,-	16 220,-	16 710,-
900	15 990,-	16 790,-	17 310,-
1000	16 560,-	17 360,-	17 910,-
1100	17 130,-	17 930,-	18 510,-
1200	17 700,-	18 500,-	19 110,-
1300	18 270,-	19 070,-	19 710,-
1400	18 840,-	19 640,-	20 310,-
1500	19 410,-	20 210,-	20 910,-
1600	19 980,-	20 780,-	21 510,-
1700	20 550,-	21 350,-	22 110,-
1800	21 120,-	21 920,-	22 710,-
1900	21 690,-	22 490,-	23 310,-
2000	22 260,-	23 060,-	23 910,-

Příplatek za atypické provedení

Boční úkos horní desky: 900,-

Otvor v horní desce: 1800,-

Pojízdné provedení: 2400,-



STŮL SKŘÍŇOVÝ S POSUVNÝMI DVÍŘKY A POLICÍ			
A - délka	B - šířka (mm)		
(mm)	600	700	800
1000	13 880,-	14 680,-	15 080,-
1100	14 550,-	15 400,-	15 850,-
1200	15 220,-	16 120,-	16 620,-
1300	15 890,-	16 840,-	17 390,-
1400	16 560,-	17 560,-	18 160,-
1500	17 230,-	18 280,-	18 930,-
1600	17 900,-	19 000,-	19 700,-
1700	18 570,-	19 720,-	20 470,-
1800	19 240,-	20 440,-	21 240,-
1900	19 910,-	21 160,-	22 100,-
2000	20 580,-	21 880,-	22 870,-

Příplatek za atypické provedení

Boční úkos horní desky: 900,-

Pojízdné provedení: 2400,-

Uzamykání dvířek: 900,-



STŮL SKŘÍŇOVÝ S POSUVNÝMI DVÍŘKY, POLICÍ A POLOVIČNÍ ŘEZNOU DESKOU			
A - délka	B - šířka (mm)		
(mm)	600	700	800
1000	15 840,-	16 640,-	17 040,-
1100	16 510,-	17 360,-	17 810,-
1200	17 180,-	18 080,-	18 580,-
1300	17 850,-	18 800,-	19 350,-
1400	18 520,-	19 520,-	20 120,-
1500	19 190,-	20 240,-	20 890,-
1600	19 860,-	20 960,-	21 660,-
1700	20 530,-	21 680,-	22 430,-
1800	21 200,-	22 400,-	23 200,-
1900	21 870,-	23 120,-	23 970,-
2000	22 540,-	23 840,-	24 740,-

Příplatek za atypické provedení

Boční úkos horní desky: 900,-

Pojízdné provedení: 2400,-

Uzamykání dvířek: 900,-



STŮL SKŘÍŇOVÝ S POSUVNÝMI DVÍŘKY A PŘESTAVITELNOU POLICÍ			
A - délka	B - šířka (mm)		
(mm)	600	700	800
1000	16 200,-	17 040,-	17 810,-
1100	16 870,-	17 760,-	18 580,-
1200	17 540,-	18 480,-	19 350,-
1300	18 210,-	19 200,-	20 120,-
1400	18 880,-	19 920,-	20 890,-
1500	19 550,-	20 640,-	21 660,-
1600	20 220,-	21 360,-	22 430,-
1700	20 890,-	22 080,-	23 200,-
1800	21 560,-	22 800,-	23 970,-
1900	22 230,-	23 520,-	24 740,-
2000	22 900,-	24 240,-	25 510,-

Příplatek za atypické provedení

Boční úkos horní desky: 900,-

Pojízdné provedení: 2400,-

Uzamykání dvířek: 900,-



STŮL SKŘÍŇOVÝ S POSUVNÝMI DVIŘKY, PŘESTAVITELNOU POLICÍ A POLOVIČNÍ ŘEZNOU DESKOU			
A - délka	B - šířka (mm)		
(mm)	600	700	800
1000	18 160,-	19 000,-	19 770,-
1100	18 830,-	19 720,-	20 540,-
1200	19 500,-	20 440,-	21 310,-
1300	20 170,-	21 160,-	22 080,-
1400	20 840,-	21 880,-	22 850,-
1500	21 510,-	22 600,-	23 620,-
1600	22 180,-	23 320,-	24 390,-
1700	22 850,-	24 040,-	25 160,-
1800	23 520,-	24 760,-	25 930,-
1900	24 190,-	25 480,-	26 700,-
2000	24 860,-	26 200,-	27 470,-

Příplatek za atypické provedení

Boční úkos horní desky: 900,-

Pojízdné provedení: 2400,-

Uzamykání dvířek: 900,-



STŮL SKŘÍŇOVÝ S KŘÍDLOVÝMI DVÍŘKY A POLICÍ			
A - délka	B - šířka (mm)		
(mm)	600	700	800
1000	13 780,-	14 580,-	14 980,-
1100	14 450,-	15 300,-	15 750,-
1200	15 120,-	16 020,-	16 520,-
1300	15 790,-	16 740,-	17 290,-
1400	16 460,-	17 460,-	18 060,-
1500	17 130,-	18 180,-	18 830,-
1600	17 800,-	18 900,-	19 600,-
1700	18 470,-	19 620,-	20 370,-
1800	19 140,-	20 340,-	21 140,-
1900	19 810,-	21 060,-	21 910,-
2000	20 480,-	21 780,-	22 680,-

Příplatek za atypické provedení

Boční úkos horní desky: 900,-

Pojízdné provedení: 2400,-

Uzamykání dvířek: 900,-

SPUKD1



STŮL SKŘÍŇOVÝ S KŘÍDLOVÝMI DVÍŘKY, POLICÍ A POLOVIČNÍ ŘEZNOU DESKOU			
A - délka	B - šířka (mm)		
(mm)	600	700	800
1000	15 740,-	16 540,-	16 940,-
1100	16 410,-	17 260,-	17 710,-
1200	17 080,-	17 980,-	18 480,-
1300	17 750,-	18 700,-	19 250,-
1400	18 420,-	19 420,-	20 020,-
1500	19 090,-	20 140,-	20 790,-
1600	19 760,-	20 860,-	21 560,-
1700	20 430,-	21 580,-	22 330,-
1800	21 100,-	22 300,-	23 100,-
1900	21 770,-	23 020,-	23 870,-
2000	22 440,-	23 740,-	24 640,-

Příplatek za atypické provedení

Boční úkos horní desky: 900,-

Pojízdné provedení: 2400,-

Uzamykání dvířek: 900,-



STŮL SKŘÍŇOVÝ S KŘÍDLOVÝMI DVÍŘKY A PŘESTAVITELNOU POLICÍ			
A - délka	B - šířka (mm)		
(mm)	600	700	800
1000	16 100,-	16 940,-	17 710,-
1100	16 770,-	17 660,-	18 480,-
1200	17 430,-	18 380,-	19 250,-
1300	18 110,-	19 100,-	20 020,-
1400	18 780,-	19 820,-	20 790,-
1500	19 450,-	20 540,-	21 560,-
1600	20 120,-	21 260,-	22 330,-
1700	20 790,-	21 980,-	23 100,-
1800	21 460,-	22 700,-	23 870,-
1900	22 130,-	23 420,-	24 640,-
2000	22 800,-	24 140,-	25 410,-

Příplatek za atypické provedení

Boční úkos horní desky: 900,-

Pojízdné provedení: 2400,-

Uzamykání dvířek: 900,-

SPPUKD1



STŮL SKŘÍŇOVÝ S KŘÍDLOVÝMI DVÍŘKY, PŘESTAVITELNOU POLICÍ A POLOVIČNÍ ŘEZNOU DESKOU			
A - délka	B - šířka (mm)		
(mm)	600	700	800
1000	18 060,-	18 900,-	19 670,-
1100	18 730,-	19 620,-	20 440,-
1200	19 400,-	20 340,-	21 210,-
1300	20 070,-	21 060,-	21 980,-
1400	20 740,-	21 780,-	22 750,-
1500	21 410,-	22 500,-	23 520,-
1600	22 080,-	23 220,-	24 290,-
1700	22 750,-	23 940,-	25 060,-
1800	23 420,-	24 660,-	25 830,-
1900	24 090,-	25 380,-	26 600,-
2000	24 760,-	26 100,-	27 370,-

Příplatek za atypické provedení

Boční úkos horní desky: 900,-

Pojízdné provedení: 2400,-

Uzamykání dvířek: 900,-

SZHT



STŮL PRACOVNÍ SE ZÁSUVKOU A TRNOŽÍ			
A - délka (mm)	B - šířka (mm)		
	600	700	800
600	10 190,-	10 600,-	11 230,-
700	10 520,-	10 940,-	11 570,-
800	10 850,-	11 280,-	11 910,-
900	11 180,-	11 620,-	12 250,-
1000	11 510,-	11 960,-	12 590,-
1100	11 840,-	12 300,-	12 930,-
1200	12 170,-	12 640,-	13 270,-
1300	12 500,-	12 980,-	13 610,-
1400	12 830,-	13 320,-	13 950,-
1500	13 160,-	13 660,-	14 290,-
1600	13 490,-	14 000,-	14 630,-
1700	13 820,-	14 340,-	14 970,-
1800	14 150,-	14 680,-	15 310,-
1900	14 480,-	15 020,-	15 650,-
2000	14 810,-	15 360,-	15 990,-

Příplatek za atypické provedení

Boční úkos horní desky: 900,-

Otvor v horní desce: 1800,-

Pojízdné provedení: 2400,-

Přidělení jedné zásuvky: 2300,-

SZHT1

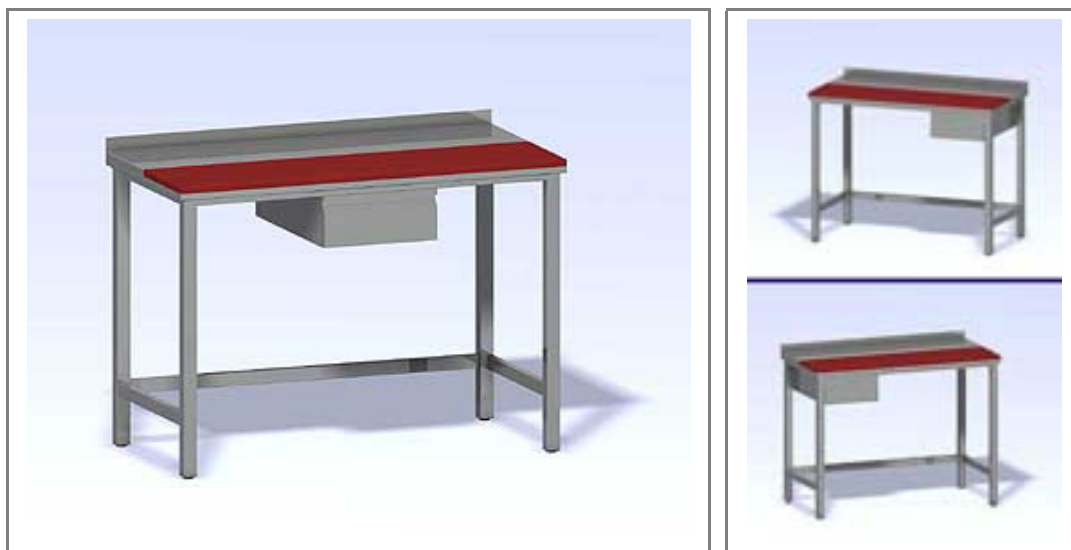

STŮL PRACOVNÍ SE ZÁSUVKOU, A TRNOŽÍ A POLOVIČNÍ ŘEZNOU DESKOU			
A - délka	B - šířka (mm)		
(mm)	600	700	800
600	11 890,-	12 300,-	12 930,-
700	12 290,-	12 700,-	13 330,-
800	12 690,-	13 100,-	13 730,-
900	13 090,-	13 500,-	14 130,-
1000	13 490,-	13 900,-	14 530,-
1100	13 890,-	14 300,-	14 930,-
1200	14 290,-	14 700,-	15 330,-
1300	14 690,-	15 100,-	15 730,-
1400	15 090,-	15 500,-	16 130,-
1500	15 490,-	15 900,-	16 530,-
1600	15 890,-	16 300,-	16 930,-
1700	16 290,-	16 700,-	17 330,-
1800	16 690,-	17 100,-	17 730,-
1900	17 090,-	17 500,-	18 130,-
2000	17 490,-	17 900,-	18 530,-

Příplatek za atypické provedení

Boční úkos horní desky: 900,-

Otvor v horní desce: 1800,-

Pojízdné provedení: 2400,-

Přidělení jedné zásuvky: 2300,-



STŮL PRACOVNÍ SE ZÁSUVKOU A JEDNOU POLICÍ			
A - délka (mm)	B - šířka (mm)		
	600	700	800
600	11 420,-	12 020,-	12 870,-
700	11 840,-	12 440,-	13 300,-
800	12 260,-	12 860,-	13 730,-
900	12 680,-	13 280,-	14 160,-
1000	13 100,-	13 700,-	14 590,-
1100	13 520,-	14 120,-	15 020,-
1200	13 940,-	14 540,-	15 450,-
1300	14 360,-	14 960,-	15 880,-
1400	14 780,-	15 380,-	16 310,-
1500	15 200,-	15 800,-	16 740,-
1600	15 620,-	16 220,-	17 170,-
1700	16 040,-	16 640,-	17 600,-
1800	16 460,-	17 060,-	18 030,-
1900	16 880,-	17 480,-	18 460,-
2000	17 300,-	17 900,-	18 890,-

Příplatek za atypické provedení

Boční úkos horní desky: 900,-

Otvor v horní desce: 1800,-

Pojízdné provedení: 2400,-

Přidělení jedné zásuvky: 2300,-

SZHP1



STŮL PRACOVNÍ S DVĚMA POLICEMI A POLOVIČNÍ ŘEZNOU DESKOU			
A - délka	B - šířka (mm)		
(mm)	600	700	800
600	12 940,-	13 620,-	14 550,-
700	13 430,-	14 120,-	15 060,-
800	13 920,-	14 620,-	15 570,-
900	14 410,-	15 120,-	16 080,-
1000	14 900,-	15 620,-	16 590,-
1100	15 390,-	16 120,-	17 100,-
1200	15 880,-	16 620,-	17 610,-
1300	16 370,-	17 120,-	18 120,-
1400	16 860,-	17 620,-	18 630,-
1500	17 350,-	18 120,-	19 140,-
1600	17 840,-	18 620,-	19 650,-
1700	18 330,-	19 120,-	20 160,-
1800	18 820,-	19 620,-	20 670,-
1900	19 310,-	20 120,-	21 180,-
2000	19 830,-	20 630,-	21 720,-

Příplatek za atypické provedení

Pojízdné provedení: 2400,-

Přidělení jedné zásuvky: 2300,-

SZB



STŮL PRACOVNÍ SE ZÁSUVKOVÝM BLOKEM A TRNOŽÍ (L,P PROVEDENÍ)			
A - délka (mm)	B - šířka (mm)		
	600	700	800
1000	15 810,-	16 250,-	17 610,-
1100	16 190,-	16 670,-	18 090,-
1200	16 570,-	17 090,-	18 570,-
1300	16 950,-	17 510,-	19 050,-
1400	17 330,-	17 930,-	19 530,-
1500	17 710,-	18 350,-	20 010,-
1600	18 090,-	18 770,-	20 490,-
1700	18 470,-	19 190,-	20 970,-
1800	18 850,-	19 610,-	21 450,-
1900	19 230,-	20 030,-	21 930,-
2000	19 610,-	20 450,-	22 410,-

Příplatek za atypické provedení

Boční úkos horní desky: 900,-

Pojízdné provedení: 2400,-

Uzamykání dvířek: 900,-

SZB1



STŮL PRACOVNÍ SE ZÁSUVKOVÝM BLOKEM, TRNOŽÍ A POLOVIČNÍ ŘEZNOU DESKOU (L,P PROVEDENÍ)

A - délka (mm)	B - šířka (mm)		
	600	700	800
1000	17 400,-	17 840,-	19 200,-
1100	17 780,-	18 260,-	19 680,-
1200	18 160,-	18 680,-	20 160,-
1300	18 540,-	19 100,-	20 640,-
1400	18 920,-	19 520,-	21 120,-
1500	19 300,-	19 940,-	21 600,-
1600	19 680,-	20 360,-	22 080,-
1700	20 060,-	20 780,-	22 560,-
1800	20 440,-	21 200,-	23 040,-
1900	20 820,-	21 620,-	23 520,-
2000	21 200,-	22 040,-	24 000,-

Příplatek za atypické provedení

Boční úkos horní desky: 900,-

Pojízdné provedení: 2400,-

Uzamykání dvířek: 900,-



STŮL PRACOVNÍ SE ZÁSUVKOVÝM BLOKEM A POLICÍ (L,P PROVEDENÍ)			
A - délka (mm)	B - šířka (mm)		
	600	700	800
1000	17 380,-	18 260,-	19 400,-
1100	17 760,-	18 680,-	19 880,-
1200	18 140,-	19 100,-	20 360,-
1300	18 520,-	19 520,-	20 840,-
1400	18 900,-	19 940,-	21 320,-
1500	19 280,-	20 360,-	21 800,-
1600	19 660,-	20 780,-	22 280,-
1700	20 040,-	21 200,-	22 760,-
1800	20 420,-	21 620,-	23 240,-
1900	20 800,-	22 040,-	23 720,-
2000	21 180,-	22 460,-	24 200,-

Příplatek za atypické provedení

Boční úkos horní desky: 900,-

Pojízdné provedení: 2400,-

Uzamykání dvířek: 900,-

SZBP1

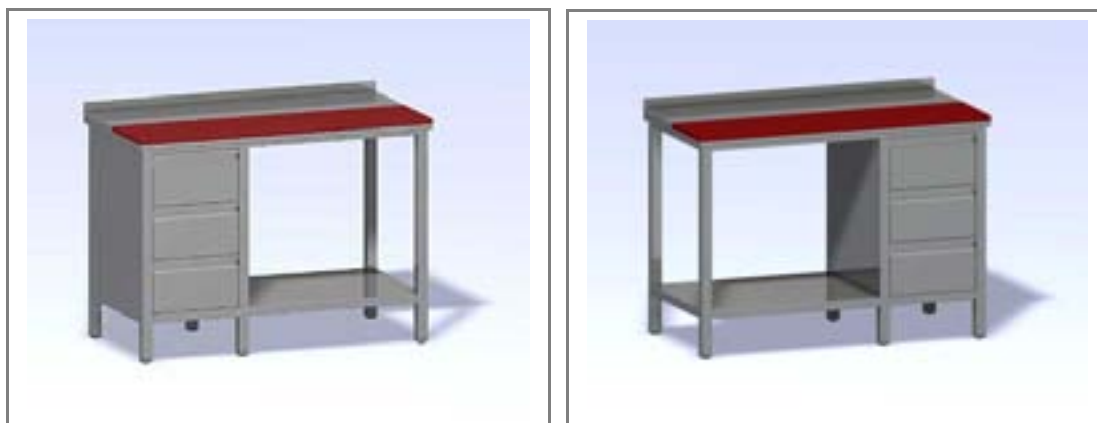

STŮL PRACOVNÍ SE ZÁSUVKOVÝM BLOKEM, POLICÍ A POLOVIČNÍ ŘEZNOU DESKOU
(L,P PROVEDENÍ)

A - délka (mm)	B - šířka (mm)		
	600	700	800
1000	19 650,-	20 640,-	21 920,-
1100	20 070,-	21 100,-	22 450,-
1200	20 490,-	21 560,-	22 980,-
1300	20 910,-	22 020,-	23 510,-
1400	21 330,-	22 480,-	24 040,-
1500	21 750,-	22 940,-	24 570,-
1600	22 170,-	23 400,-	25 100,-
1700	22 590,-	23 860,-	25 630,-
1800	23 010,-	24 320,-	26 160,-
1900	23 430,-	24 780,-	26 690,-
2000	23 860,-	25 250,-	27 200,-

Příplatek za atypické provedení

Boční úkos horní desky: 900,-

Pojízdné provedení: 2400,-

Uzamykání dvířek: 900,-

SZBUP-PD



STŮL PRACOVNÍ SE ZÁSUVKOVÝM BLOKEM, POLICÍ A POSUVNÝMI DVÍŘKY (L,P PROVEDENÍ)

A - délka (mm)	B - šířka (mm)		
	600	700	800
1500	27 200,-	28 440,-	30 040,-
1600	27 940,-	29 250,-	30 920,-
1700	28 680,-	30 060,-	31 800,-
1800	29 420,-	30 870,-	32 680,-
1900	30 160,-	31 680,-	33 560,-
2000	30 900,-	32 490,-	34 440,-

Příplatek za atypické provedení

Boční úkos horní desky: 900,-

Pojízdné provedení: 2400,-

Uzamykání dvířek: 900,-

SZBUP-PD1



STŮL PRACOVNÍ SE ZÁSUVKOVÝM BLOKEM, POLICÍ, POSUVNÝMI DVÍŘKY A POLOVIČNÍ ŘEZNOU DESKOU (L,P PROVEDENÍ)			
A - délka	B - šířka (mm)		
(mm)	600	700	800
1500	28 700,-	29 940,-	31 540,-
1600	29 440,-	30 750,-	32 420,-
1700	30 180,-	31 560,-	33 300,-
1800	30 920,-	32 370,-	34 180,-
1900	31 660,-	33 180,-	35 060,-
2000	32 400,-	33 990,-	35 940,-

Příplatek za atypické provedení

Boční úkos horní desky: 900,-

Pojízdné provedení: 2400,-

Uzamykání dvířek: 900,-

SZBUPP-PD



STŮL PRACOVNÍ SE ZÁSUVKOVÝM BLOKEM, PŘESTEVITELNOU POLICÍ A POSUVNÝMI DVÍŘKY (L,P PROVEDENÍ)

A - délka (mm)	B - šířka (mm)		
	600	700	800
1500	27 200,-	28 440,-	30 040,-
1600	27 940,-	29 250,-	30 920,-
1700	28 650,-	30 060,-	31 800,-
1800	29 420,-	30 870,-	32 680,-
1900	30 160,-	31 680,-	33 560,-
2000	30 900,-	32 490,-	34 440,-

Příplatek za atypické provedení

Boční úkos horní desky: 900,-

Pojízdné provedení: 2400,-

Uzamykání dvířek: 900,-

SZBUPP-PD1



STŮL PRACOVNÍ SE ZÁSUVKOVÝM BLOKEM, PŘESTEVITELNOU POLICÍ, POSUVNÝMI DVÍŘKY A POLOVIČNÍ ŘEZNOU DESKOU (L,P PROVEDENÍ)

A - délka (mm)	B - šířka (mm)		
	600	700	800
1500	28 700,-	29 940,-	31 540,-
1600	29 440,-	30 750,-	32 420,-
1700	30 180,-	31 560,-	33 300,-
1800	30 920,-	32 370,-	34 180,-
1900	31 660,-	33 180,-	35 060,-
2000	32 400,-	33 990,-	35 940,-

Příplatek za atypické provedení

Boční úkos horní desky: 900,-

Pojízdné provedení: 2400,-

Uzamykání dvířek: 900,-



STŮL PRACOVNÍ SE ZÁSUVKOVÝM BLOKEM, POLICÍ A OTVÍRAVÝMI DVÍŘKY (L,P PROVEDENÍ)			
A - délka	B - šířka (mm)		
(mm)	600	700	800
1500	27 100,-	28 340,-	29 940,-
1600	27 840,-	29 150,-	30 820,-
1700	28 550,-	29 960,-	31 700,-
1800	29 320,-	30 770,-	32 580,-
1900	30 060,-	31 580,-	33 460,-
2000	30 800,-	32 390,-	34 340,-

Příplatek za atypické provedení

Boční úkos horní desky: 900,-

Pojízdné provedení: 2400,-

Uzamykání dvířek: 900,-

SZBUP-KD1



STŮL PRACOVNÍ SE ZÁSUVKOVÝM BLOKEM, POLICÍ, OTVÍRAVÝMI DVÍŘKY A POLOVIČNÍ ŘEZNOU DESKOU (L,P PŘÍKONÍ)			
A - délka	B - šířka (mm)		
(mm)	600	700	800
1500	28 600,-	29 840,-	31 440,-
1600	29 340,-	30 650,-	32 320,-
1700	30 080,-	31 460,-	33 200,-
1800	30 820,-	32 270,-	34 080,-
1900	31 560,-	33 080,-	34 960,-
2000	32 300,-	33 890,-	35 840,-

Příplatek za atypické provedení

Boční úkos horní desky: 900,-

Pojízdné provedení: 2400,-

Uzamykání dvířek: 900,-



STŮL PRACOVNÍ SE ZÁSUVKOVÝM BLOKEM, PŘESTAVITELNOU POLICÍ A OTVÍRAVÝMI DVÍŘKY (L,P PROVEDENÍ)

A - délka (mm)	B - šířka (mm)		
	600	700	800
1500	28 780,-	30 160,-	32 030,-
1600	28 520,-	30 970,-	32 910,-
1700	29 260,-	31 780,-	33 790,-
1800	30 000,-	32 590,-	34 670,-
1900	30 740,-	33 400,-	35 550,-
2000	31 480,-	34 210,-	36 430,-

Příplatek za atypické provedení

Boční úkos horní desky: 900,-

Pojízdné provedení: 2400,-

Uzamykání dvířek: 900,-

SZBUPP-KD1



STŮL PRACOVNÍ SE ZÁSUVKOVÝM BLOKEM, PŘESTAVITELNOU POLICÍ, OTVÍRAVÝMI DVÍŘKY A POLOVIČNÍ ŘEZNOU DESKOU (L,P PŘEVEDENÍ)

A - délka (mm)	B - šířka (mm)		
	600	700	800
1500	30 280,-	31 660,-	33 530,-
1600	31 020,-	32 470,-	34 410,-
1700	31 760,-	33 280,-	35 290,-
1800	32 500,-	34 090,-	36 170,-
1900	33 240,-	34 900,-	37 050,-
2000	33 980,-	35 710,-	37 930,-

Příplatek za atypické provedení

Boční úkos horní desky: 900,-

Pojízdné provedení: 2400,-

Uzamykání dvířek: 900,-



STŮL PRACOVNÍ SE VSUVY NA GN 1/1 – OTEVŘENÝ (L,P PROVEDENÍ)			
A - délka (mm)	B - šířka (mm)		
	600	700	800
1000	11 380,-	11 840,-	12 710,-
1100	11 800,-	12 260,-	13 140,-
1200	12 220,-	12 680,-	13 570,-
1300	12 640,-	13 100,-	14 000,-
1400	13 060,-	13 520,-	14 430,-
1500	13 480,-	13 940,-	14 860,-
1600	13 900,-	14 360,-	15 290,-
1700	14 320,-	14 780,-	15 720,-
1800	14 740,-	15 200,-	16 150,-
1900	15 160,-	15 620,-	16 580,-
2000	15 580,-	16 040,-	17 010,-

Příplatek za atypické provedení

Boční úkos horní desky: 900,-

Pojízdné provedení: 2400,-

Otvor v horní desce: 1 800,-

SPGN1



STŮL PRACOVNÍ SE VSUVY NA GN 1/1 A POLOVIČNÍ ŘEZNOU DESKOU – OTEVŘENÝ
(L,P PROVEDENÍ)

A - délka (mm)	B - šířka (mm)		
	600	700	800
1000	12 980,-	13 980,-	15 450,-
1100	13 400,-	14 400,-	15 880,-
1200	13 820,-	14 820,-	16 310,-
1300	14 240,-	15 240,-	16 740,-
1400	14 660,-	15 660,-	17 170,-
1500	15 080,-	16 080,-	17 600,-
1600	15 500,-	16 500,-	18 030,-
1700	15 920,-	16 920,-	18 460,-
1800	16 340,-	17 340,-	18 890,-
1900	16 760,-	17 760,-	19 320,-
2000	17 180,-	18 180,-	19 750,-

Příplatek za atypické provedení

Boční úkos horní desky: 900,-

Pojízdné provedení: 2400,-

Otvor v horní desce: 1 800,-

SPUGN



STŮL PRACOVNÍ SE VSUVY NA GN 1/1 – OPLÁŠTĚNÍ VSUVŮ ZE TŘÍ STRAN (L,P PROVEDENÍ)

A - délka (mm)	B - šířka (mm)		
	600	700	800
1000	13 880,-	14 340,-	15 210,-
1100	14 300,-	14 760,-	15 640,-
1200	14 720,-	15 180,-	16 070,-
1300	15 140,-	15 600,-	16 500,-
1400	15 560,-	16 020,-	16 930,-
1500	15 980,-	16 440,-	17 360,-
1600	16 400,-	16 860,-	17 790,-
1700	16 820,-	17 280,-	18 220,-
1800	17 240,-	17 700,-	18 650,-
1900	17 660,-	18 120,-	19 080,-
2000	18 080,-	18 540,-	19 510,-

Příplatek za atypické provedení

Boční úkos horní desky: 900,-

Pojízdné provedení: 2400,-

Otvor v horní desce: 1 800,-

SPUGN1



STŮL PRACOVNÍ SE VSUVY NA GN 1/1 – OPLÁŠTĚNÍ VSUVŮ ZE TŘÍ STRAN A POLOVIČNÍ ŘEZNOU DESKOU (L,P PROVEDENÍ)

A - délka (mm)	B - šířka (mm)		
	600	700	800
1000	15 480,-	16 480,-	17 950,-
1100	15 900,-	16 900,-	18 380,-
1200	16 320,-	17 320,-	18 810,-
1300	16 740,-	17 740,-	19 240,-
1400	17 160,-	18 160,-	19 670,-
1500	17 580,-	18 580,-	20 100,-
1600	18 000,-	19 000,-	20 530,-
1700	18 420,-	19 420,-	20 960,-
1800	18 840,-	19 840,-	21 390,-
1900	19 260,-	20 260,-	21 820,-
2000	19 680,-	20 680,-	22 250,-

Příplatek za atypické provedení

Boční úkos horní desky: 900,-

Pojízdné provedení: 2400,-

Otvor v horní desce: 1 800,-

SZB2



STŮL PRACOVNÍ – ZÁSUVKOVÝ BOX – 2 ZÁSUVKY			
A - délka	B - šířka (mm)		
(mm)	600	700	800
400	10 030,-	10 250,-	10 470,-
500	10 530,-	10 750,-	10 970,-
600	11 030,-	11 250,-	11 470,-
700	11 530,-	11 750,-	11 970,-
800	12 030,-	12 250,-	12 470,-

Příplatek za atypické provedení

Boční úkos horní desky: 900,-

Pojízdné provedení: 2400,-

Otvor v horní desce: 1 800,-

SZB3

STŮL PRACOVNÍ – ZÁSUVKOVÝ BOX – 3 ZÁSUVKY			
A - délka	B - šířka (mm)		
(mm)	600	700	800
400	11 730,-	11 950,-	12 170,-
500	12 330,-	12 550,-	12 770,-
600	12 930,-	13 150,-	13 370,-
700	13 530,-	13 750,-	13 970,-
800	14 130,-	14 350,-	14 570,-

Příplatek za atypické provedení

Boční úkos horní desky: 900,-

Pojízdné provedení: 2400,-

Otvor v horní desce: 1 800,-

SMD



STŮL MYCÍ S JEDNÍM DŘEZEM – BEZ POLICE (L,P PROVEDENÍ)			
Vnější A x B (mm)	Rozměr dřezu	typ	cena
1200 x 600	400 x 400 x 250	SMD1	13 450,-
1300 x 600			13 650,-
1400 x 600			13 850,-
1500 x 600			14 050,-
1600 x 600			14 250,-
1700 x 600			14 450,-
1800 x 600			14 650,-
1200 x 700	400 x 400 x 250	SMD1	13 950,-
1300 x 700			14 210,-
1400 x 700			14 480,-
1500 x 700			14 740,-
1600 x 700			15 010,-
1700 x 700			15 270,-
1800 x 700			15 540,-
1200 x 700	500 x 500 x 250	SMD2	16 830,-
1300 x 700			17 130,-
1400 x 700			17 430,-
1500 x 700			17 730,-
1600 x 700			18 030,-
1700 x 700			18 330,-
1800 x 700			18 830,-
1200 x 700	500 x 500 x 300	SMD3	17 330,-
1300 x 700			17 580,-
1400 x 700			17 830,-
1500 x 700			18 080,-
1600 x 700			18 330,-
1700 x 700			18 580,-
1800 x 700			18 830,-
1800 x 700	500 x 600 x 350	SMD4	19 350,-

Příplatek za atypické provedení: Otvor pro pákovou baterii: 150,-

SMD



STŮL MYCÍ S JEDNÍM DŘEZEM S POLICÍ (L,P PROVEDENÍ)			
Vnější A x B (mm)	Rozměr dřezu	typ	cena
1200 x 600	400 x 400 x 250	SMD1	16 180,-
1300 x 600			16 480,-
1400 x 600			16 790,-
1500 x 600			17 090,-
1600 x 600			17 400,-
1700 x 600			17 700,-
1800 x 600			18 010,-
1200 x 700	400 x 400 x 250	SMD1	17 020,-
1300 x 700			17 390,-
1400 x 700			17 760,-
1500 x 700			18 130,-
1600 x 700			18 500,-
1700 x 700			18 870,-
1800 x 700			19 240,-
1200 x 700	500 x 500 x 250	SMD2	20 280,-
1300 x 700			21 080,-
1400 x 700			21 880,-
1500 x 700			22 680,-
1600 x 700			23 480,-
1700 x 700			24 280,-
1800 x 700			25 080,-
1200 x 700	500 x 500 x 300	SMD3	20 780,-
1300 x 700			21 130,-
1400 x 700			21 480,-
1500 x 700			21 830,-
1600 x 700			22 180,-
1700 x 700			22 530,-
1800 x 700			22 880,-
1800 x 700	500 x 600 x 350	SMD4	23 570,-

Příplatek za atypické provedení: Otvor pro pákovou baterii: 150,-

SMDR



STŮL MYCÍ S JEDNÍM DŘEZEM A ROŠTOVOU POLICÍ (L,P PROVEDENÍ)			
Vnější A x B (mm)	Rozměr dřezu	typ	cena
1200 x 600	400 x 400 x 250	SMD1	16 020,-
1300 x 600			16 320,-
1400 x 600			16 620,-
1500 x 600			16 920,-
1600 x 600			17 220,-
1700 x 600			17 520,-
1800 x 600			17 820,-
1200 x 700	400 x 400 x 250	SMD1	16 740,-
1300 x 700			17 040,-
1400 x 700			17 340,-
1500 x 700			17 640,-
1600 x 700			17 940,-
1700 x 700			18 240,-
1800 x 700			18 540,-
1200 x 700	500 x 500 x 250	SMD2	19 970,-
1300 x 700			20 370,-
1400 x 700			20 770,-
1500 x 700			21 170,-
1600 x 700			21 570,-
1700 x 700			21 970,-
1800 x 700			22 370,-
1200 x 700	500 x 500 x 300	SMD3	20 470,-
1300 x 700			20 820,-
1400 x 700			21 170,-
1500 x 700			21 520,-
1600 x 700			21 870,-
1700 x 700			22 220,-
1800 x 700			22 570,-
1800 x 700	500 x 600 x 350	SMD4	23 180,-

Otvor pro pákovou baterii:150,-

SMDZ



STŮL MYCÍ S JEDNÍM DŘEZEM A ZÁSUVKOU – BEZ POLICE (L,P PROVEDENÍ)			
Vnější A x B (mm)	Rozměr dřezu	typ	cena
1200 x 600	400 x 400 x 250	SMD1	15 750,-
1300 x 600			15 950,-
1400 x 600			16 150,-
1500 x 600			16 350,-
1600 x 600			16 550,-
1700 x 600			16 750,-
1800 x 600			16 950,-
1200 x 700			400 x 400 x 250
1300 x 700	16 510,-		
1400 x 700	16 770,-		
1500 x 700	17 030,-		
1600 x 700	17 290,-		
1700 x 700	17 550,-		
1800 x 700	17 810,-		
1200 x 700	500 x 500 x 250	SMD2	
1300 x 700			19 430,-
1400 x 700			19 730,-
1500 x 700			20 030,-
1600 x 700			20 330,-
1700 x 700			20 630,-
1800 x 700			20 930,-
1200 x 700			500 x 500 x 300
1300 x 700	19 880,-		
1400 x 700	20 130,-		
1500 x 700	20 380,-		
1600 x 700	20 630,-		
1700 x 700	20 880,-		
1800 x 700	21 180,-		
1800 x 700	500 x 600 x 350	SMD4	

Otvor pro pákovou baterii: 150,-

SMDZP



STŮL MYCÍ S JEDNÍM DŘEZEM, ZÁSUVKOU A POLICÍ (L,P PROVEDENÍ)			
Vnější A x B (mm)	Rozměr dřezu	typ	cena
1200 x 600	400 x 400 x 250	SMD1	18 480,-
1300 x 600			18 780,-
1400 x 600			19 080,-
1500 x 600			19 380,-
1600 x 600			19 680,-
1700 x 600			19 980,-
1800 x 600			20 280,-
1200 x 700			400 x 400 x 250
1300 x 700	19 690,-		
1400 x 700	20 060,-		
1500 x 700	20 430,-		
1600 x 700	20 800,-		
1700 x 700	21 170,-		
1800 x 700	21 540,-		
1200 x 700	500 x 500 x 250	SMD2	
1300 x 700			23 380,-
1400 x 700			24 180,-
1500 x 700			24 980,-
1600 x 700			25 780,-
1700 x 700			26 580,-
1800 x 700			27 380,-
1200 x 700			500 x 500 x 300
1300 x 700	23 430,-		
1400 x 700	23 780,-		
1500 x 700	24 130,-		
1600 x 700	24 480,-		
1700 x 700	24 830,-		
1800 x 700	25 180,-		
1800 x 700	500 x 600 x 350	SMD4	

Otvor pro pákovou baterii: 150,-

SMDZR



STŮL MYCÍ S JEDNÍM DŘEZEM, ZÁSUVKOU A ROŠTOVOU POLICÍ (L,P PROVEDENÍ)			
Vnější A x B (mm)	Rozměr dřezu	typ	cena
1200 x 600	400 x 400 x 250	SMD1	18 320,-
1300 x 600			18 620,-
1400 x 600			18 920,-
1500 x 600			19 220,-
1600 x 600			19 520,-
1700 x 600			19 820,-
1800 x 600			20 120,-
1200 x 700			400 x 400 x 250
1300 x 700	19 340,-		
1400 x 700	19 640,-		
1500 x 700	19 940,-		
1600 x 700	20 240,-		
1700 x 700	20 540,-		
1800 x 700	20 840,-		
1200 x 700	500 x 500 x 250	SMD2	
1300 x 700			22 670,-
1400 x 700			23 070,-
1500 x 700			23 470,-
1600 x 700			23 870,-
1700 x 700			24 270,-
1800 x 700			24 670,-
1200 x 700			500 x 500 x 300
1300 x 700	23 120,-		
1400 x 700	23 470,-		
1500 x 700	23 820,-		
1600 x 700	24 170,-		
1700 x 700	24 520,-		
1800 x 700	24 870,-		
1800 x 700	500 x 600 x 350	SMD4	

Otvor pro pákovou baterii:150,-

SMDZB



STŮL MYCÍ S JEDNÍM DŘEZEM A ZÁSUVKOVÝM BOXEM – BEZ POLICE (L,P PROVEDENÍ)			
Vnější A x B (mm)	Rozměr dřezu	typ	cena
1200 x 600	400 x 400 x 250	SMD1	26 150,-
1300 x 600			26 350,-
1400 x 600			26 550,-
1500 x 600			26 750,-
1600 x 600			26 950,-
1700 x 600			27 150,-
1800 x 600			27 350,-
1200 x 700			400 x 400 x 250
1300 x 700	26 890,-		
1400 x 700	27 130,-		
1500 x 700	27 370,-		
1600 x 700	27 610,-		
1700 x 700	27 850,-		
1800 x 700	28 090,-		
1200 x 700	500 x 500 x 250	SMD2	
1300 x 700			29 830,-
1400 x 700			30 130,-
1500 x 700			30 430,-
1600 x 700			30 730,-
1700 x 700			31 030,-
1800 x 700			31 330,-
1200 x 700			500 x 500 x 300
1300 x 700	30 280,-		
1400 x 700	30 530,-		
1500 x 700	30 780,-		
1600 x 700	31 030,-		
1700 x 700	31 280,-		
1800 x 700	31 530,-		
1800 x 700	500 x 600 x 350	SMD4	

Otvor pro pákovou baterii:150,-

SMDZBP



STŮL MYCÍ S JEDNÍM DŘEZEM, ZÁSUVKOVÝM BOXEM A POLICÍ (L,P PŘEVEDENÍ)			
Vnější A x B (mm)	Rozměr dřezu	typ	cena
1200 x 600	400 x 400 x 250	SMD1	28 880,-
1300 x 600			29 180,-
1400 x 600			29 480,-
1500 x 600			29 780,-
1600 x 600			30 080,-
1700 x 600			30 380,-
1800 x 600			30 680,-
1200 x 700	400 x 400 x 250	SMD1	29 720,-
1300 x 700			30 090,-
1400 x 700			30 460,-
1500 x 700			30 830,-
1600 x 700			31 200,-
1700 x 700			31 570,-
1800 x 700			31 940,-
1200 x 700	500 x 500 x 250	SMD2	32 980,-
1300 x 700			33 380,-
1400 x 700			33 780,-
1500 x 700			34 180,-
1600 x 700			34 580,-
1700 x 700			34 980,-
1800 x 700			35 380,-
1200 x 700	500 x 500 x 300	SMD3	33 480,-
1300 x 700			33 830,-
1400 x 700			34 180,-
1500 x 700			34 530,-
1600 x 700			34 880,-
1700 x 700			35 230,-
1800 x 700			35 580,-
1800 x 700	500 x 600 x 350	SMD4	36 270,-

Otvor pro pákovou baterii: 150,-

SMDZBR



STŮL MYCÍ S JEDNÍM DŘEZEM, A ZÁSUVKOVÝM BOXEM A ROŠTOVOU POLICÍ (L,P PROVEDENÍ)			
Vnější A x B (mm)	Rozměr dřezu	typ	cena
1200 x 600	400 x 400 x 250	SMD1	28 720,-
1300 x 600			29 020,-
1400 x 600			29 320,-
1500 x 600			29 620,-
1600 x 600			29 920,-
1700 x 600			30 220,-
1800 x 600			30 520,-
1200 x 700	400 x 400 x 250	SMD1	29 440,-
1300 x 700			29 740,-
1400 x 700			30 110,-
1500 x 700			30 480,-
1600 x 700			30 850,-
1700 x 700			31 220,-
1800 x 700			31 590,-
1200 x 700	500 x 500 x 250	SMD2	32 670,-
1300 x 700			33 070,-
1400 x 700			33 470,-
1500 x 700			33 870,-
1600 x 700			34 270,-
1700 x 700			34 670,-
1800 x 700			35 070,-
1200 x 700	500 x 500 x 300	SMD3	33 170,-
1300 x 700			33 520,-
1400 x 700			33 870,-
1500 x 700			34 220,-
1600 x 700			34 570,-
1700 x 700			34 920,-
1800 x 700			35 270,-
1800 x 700	500 x 600 x 350	SMD4	35 880,-

Otvor pro pákovou baterii: 150,-

SMDUP-PD



STŮL MYCÍ S POSUVNÝMI DVÍŘKYA POLICÍ (L,P PROVEDENÍ)			
Vnější A x B (mm)	Rozměr dřezu	typ	cena
1200 x 600	400 x 400 x 250	SMD1	19 700,-
1300 x 600			20 000,-
1400 x 600			20 300,-
1500 x 600			20 600,-
1600 x 600			20 900,-
1700 x 600			21 200,-
1800 x 600			21 500,-
1200 x 700	400 x 400 x 250	SMD1	20 600,-
1300 x 700			21 000,-
1400 x 700			21 400,-
1500 x 700			21 800,-
1600 x 700			22 200,-
1700 x 700			22 600,-
1800 x 700			23 000,-
1200 x 700	500 x 500 x 250	SMD2	21 400,-
1300 x 700			21 800,-
1400 x 700			22 200,-
1500 x 700			22 600,-
1600 x 700			23 000,-
1700 x 700			23 400,-
1800 x 700			23 800,-
1200 x 700	500 x 500 x 300	SMD3	21 600,-
1300 x 700			22 000,-
1400 x 700			22 400,-
1500 x 700			22 800,-
1600 x 700			23 200,-
1700 x 700			23 600,-
1800 x 700			24 000,-
1800 x 700	500 x 600 x 350	SMD4	24 800,-

Otvor pro pákovou baterii: 150,-



STŮL MYCÍ S JEDNÍM DŘEZEM, ZÁSUVKOVÝM BOXEM, POLICÍ A POSUVNÝMI DVÍŘKY (L,P PROVEDENÍ)			
Vnější A x B (mm)	Rozměr dřezu	typ	cena
1200 x 600	400 x 400 x 250	SMD1	32 700,-
1300 x 600			33 000,-
1400 x 600			33 300,-
1500 x 600			33 600,-
1600 x 600			33 900,-
1700 x 600			34 200,-
1800 x 600			34 500,-
1200 x 700			400 x 400 x 250
1300 x 700	34 000,-		
1400 x 700	34 400,-		
1500 x 700	34 800,-		
1600 x 700	35 200,-		
1700 x 700	35 600,-		
1800 x 700	36 000,-		
1200 x 700	500 x 500 x 250	SMD2	
1300 x 700			34 800,-
1400 x 700			35 200,-
1500 x 700			35 600,-
1600 x 700			36 000,-
1700 x 700			36 400,-
1800 x 700			36 800,-
1200 x 700			500 x 500 x 300
1300 x 700	35 000,-		
1400 x 700	35 400,-		
1500 x 700	35 800,-		
1600 x 700	36 200,-		
1700 x 700	36 600,-		
1800 x 700	37 000,-		
1800 x 700	500 x 600 x 350	SMD4	

Otvor pro pákovou baterii: 150,-



STŮL MYCÍ S JEDNÍM DŘEZEM, ZÁSUVKOVÝM BOXEM, POLICÍ A KŘÍDLOVÝMI DVIŘKY (L,P PROVEDENÍ)

Vnější A x B (mm)	Rozměr dřezu	typ	cena
1200 x 600	400 x 400 x 250	SMD1	32 700,-
1300 x 600			33 000,-
1400 x 600			33 300,-
1500 x 600			33 600,-
1600 x 600			33 900,-
1700 x 600			34 200,-
1800 x 600			34 500,-
1200 x 700	400 x 400 x 250	SMD1	33 600,-
1300 x 700			34 000,-
1400 x 700			34 400,-
1500 x 700			34 800,-
1600 x 700			35 200,-
1700 x 700			35 600,-
1800 x 700			36 000,-
1200 x 700	500 x 500 x 250	SMD2	34 400,-
1300 x 700			34 800,-
1400 x 700			35 200,-
1500 x 700			35 600,-
1600 x 700			36 000,-
1700 x 700			36 400,-
1800 x 700			36 800,-
1200 x 700	500 x 500 x 300	SMD3	34 600,-
1300 x 700			35 000,-
1400 x 700			35 400,-
1500 x 700			35 800,-
1600 x 700			36 200,-
1700 x 700			36 600,-
1800 x 700			37 000,-
1800 x 700	500 x 600 x 350	SMD4	37 800,-

Otvor pro pákovou baterii: 150,-

SMDV



STŮL MYCÍ SE DVĚMA DŘEZY – BEZ POLICE (L,P PROVEDENÍ)			
Vnější A x B (mm)	Rozměr dřezu	typ	cena
1400 x 600	400 x 400 x 250	SMDV1	15 860,-
1500 x 600			16 000,-
1600 x 600			16 260,-
1700 x 600			16 700,-
1800 x 600			17 140,-
1400 x 700	400 x 400 x 250	SMDV1	17 910,-
1500 x 700			18 180,-
1600 x 700			18 460,-
1700 x 700			18 720,-
1800 x 700			18 980,-
1400 x 700	500 x 500 x 250	SMDV2	22 290,-
1500 x 700			22 580,-
1600 x 700			22 880,-
1700 x 700			23 180,-
1800 x 700			23 470,-
1400 x 700	500 x 500 x 300	SMDV3	24 370,-
1500 x 700			24 620,-
1600 x 700			24 880,-
1700 x 700			25 150,-
1800 x 700			25 420,-
1800 x 700	500 x 600 x 350	SMDV4	26 850,-

Otvor pro pákovou baterii: 150,-

SMDVP



STŮL MYCÍ SE DVĚMA DŘEZY A POLICÍ (L,P PROVEDENÍ)			
Vnější A x B (mm)	Rozměr dřezu	typ	cena
1400 x 600	400 x 400 x 250	SMDV1	18 450,-
1500 x 600			18 750,-
1600 x 600			19 040,-
1700 x 600			19 590,-
1800 x 600			20 130,-
1400 x 700	400 x 400 x 250	SMDV1	20 690,-
1500 x 700			21 320,-
1600 x 700			21 650,-
1700 x 700			21 950,-
1800 x 700			22 250,-
1400 x 700	500 x 500 x 250	SMDV2	24 870,-
1500 x 700			25 260,-
1600 x 700			25 650,-
1700 x 700			26 080,-
1800 x 700			26 510,-
1400 x 700	500 x 500 x 300	SMDV3	27 250,-
1500 x 700			27 610,-
1600 x 700			27 970,-
1700 x 700			28 150,-
1800 x 700			28 330,-
1800 x 700	500 x 600 x 350	SMDV4	28 630,-

Otvor pro pákovou baterii:150,-

SMDVR



STŮL MYCÍ SE DVĚMA DŘEZY A ROŠTOVOU POLICÍ (L,P PROVEDENÍ)			
Vnější A x B (mm)	Rozměr dřezu	typ	cena
1400 x 600	400 x 400 x 250	SMDV1	19 280,-
1500 x 600			19 580,-
1600 x 600			19 890,-
1700 x 600			20 390,-
1800 x 600			20 890,-
1400 x 700	400 x 400 x 250	SMDV1	21 630,-
1500 x 700			22 010,-
1600 x 700			22 380,-
1700 x 700			22 700,-
1800 x 700			23 010,-
1400 x 700	500 x 500 x 250	SMDV2	25 400,-
1500 x 700			25 800,-
1600 x 700			26 190,-
1700 x 700			26 540,-
1800 x 700			26 890,-
1400 x 700	500 x 500 x 300	SMDV3	27 490,-
1500 x 700			27 860,-
1600 x 700			28 220,-
1700 x 700			28 530,-
1800 x 700			28 840,-
1800 x 700	500 x 600 x 350	SMDV4	29 900,-

Příplatek za atypické provedení: Otvor pro pákovou baterii:150,-

SMDVZ-2



STŮL MYCÍ SE DVĚMA DŘEZY A ZÁSUVKOU – BEZ POLICE (L,P PŘEVODENÍ)			
Vnější A x B (mm)	Rozměr dřezu	typ	cena
1400 x 600	400 x 340 x 250	SMDV1	18 160,-
1500 x 600			18 300,-
1600 x 600			18 560,-
1700 x 600			19 000,-
1800 x 600			19 440,-
1400 x 700	400 x 340 x 250	SMDV1	20 210,-
1500 x 700			20 480,-
1600 x 700			20 760,-
1700 x 700			21 020,-
1800 x 700			21 280,-
	500 x 500 x 250	SMDV2	
1600 x 700			25 180,-
1700 x 700			25 480,-
1800 x 700			25 770,-
	500 x 500 x 300	SMDV3	
1600 x 700			27 180,-
1700 x 700			27 450,-
1800 x 700			27 720,-
1800 x 700	500 x 600 x 350	SMDV4	29 150,-

Otvor pro pákovou baterii: 150,-

SMDVZP-2



STŮL MYCÍ SE DVĚMA DŘEZY, ZÁSUVKOU A POLICÍ (L,P PŘEVEDENÍ)			
Vnější A x B (mm)	Rozměr dřezu	typ	cena
1400 x 600	400 x 340 x 250	SMDV1	18 450,-
1500 x 600			18 750,-
1600 x 600			19 040,-
1700 x 600			19 590,-
1800 x 600			20 130,-
1400 x 700	400 x 340 x 250	SMDV1	20 690,-
1500 x 700			21 320,-
1600 x 700			21 650,-
1700 x 700			21 950,-
1800 x 700			22 250,-
	500 x 500 x 250	SMDV2	
1600 x 700			27 950,-
1700 x 700			28 380,-
1800 x 700		28 810,-	
	500 x 500 x 300	SMDV3	
1600 x 700			30 270,-
1700 x 700			30 450,-
1800 x 700		30 630,-	
1800 x 700	500 x 600 x 350	SMDV4	30 930,-

Otvor pro pákovou baterii:150,-

SMDVZR-2



STŮL MYCÍ SE DVĚMA DŘEZY, ZÁSUVKOU A ROŠTOVOU POLICÍ (L,P PROVEDENÍ)			
Vnější A x B (mm)	Rozměr dřezu	typ	cena
1400 x 600	400 x 340 x 250	SMDV1	21 580,-
1500 x 600			21 880,-
1600 x 600			22 190,-
1700 x 600			22 690,-
1800 x 600			23 190,-
1400 x 700	400 x 340 x 250	SMDV1	23 930,-
1500 x 700			24 310,-
1600 x 700			24 680,-
1700 x 700			25 000,-
1800 x 700			25 310,-
	500 x 500 x 250	SMDV2	
1600 x 700			28 490,-
1700 x 700			28 840,-
1800 x 700			29 190,-
	500 x 500 x 300	SMDV3	
1600 x 700			30 520,-
1700 x 700			30 830,-
1800 x 700			31 140,-
1800 x 700	500 x 600 x 350	SMDV4	32 200,-

Otvor pro pákovou baterii:150,-

SMDVUZB-2



STŮL MYCÍ SE DVĚMA DŘEZY A ZÁSUVKOVÝM BOXEM – BEZ POLICE (L,P PROVEDENÍ)			
Vnější A x B (mm)	Rozměr dřezu	typ	cena
1400 x 600	400 x 340 x 250	SMDV1	28 560,-
1500 x 600			28 700,-
1600 x 600			28 960,-
1700 x 600			29 400,-
1800 x 600			29 840,-
1400 x 700	400 x 340 x 250	SMDV1	30 610,-
1500 x 700			30 880,-
1600 x 700			31 160,-
1700 x 700			31 420,-
1800 x 700			31 680,-
	500 x 500 x 250	SMDV2	
1600 x 700			35 580,-
1700 x 700			35 880,-
1800 x 700			36 170,-
	500 x 500 x 300	SMDV3	
1600 x 700			37 580,-
1700 x 700			37 850,-
1800 x 700			38 120,-
1800 x 700	500 x 600 x 350	SMDV4	39 550,-

Otvor pro pákovou baterii: 150,-

SMDVUZBP-2



STŮL MYCÍ SE DVĚMA DŘEZY, ZÁSUVKOVÝM BOXEM A POLICÍ (L,P PROVEDENÍ)			
Vnější A x B (mm)	Rozměr dřezu	typ	cena
1400 x 600	400 x 340 x 250	SMDV1	30 260,-
1500 x 600			30 400,-
1600 x 600			30 540,-
1700 x 600			30 680,-
1800 x 600			30 820,-
1400 x 700	400 x 340 x 250	SMDV1	32 300,-
1500 x 700			32 570,-
1600 x 700			32 840,-
1700 x 700			33 110,-
1800 x 700			33 380,-
	500 x 500 x 250	SMDV2	
1600 x 700			37 480,-
1700 x 700			37 780,-
1800 x 700			38 080,-
	500 x 500 x 300	SMDV3	
1600 x 700			39 480,-
1700 x 700			39 780,-
1800 x 700	40 080,-		
1800 x 700	500 x 600 x 350	SMDV4	41 500,-

Otvor pro pákovou baterii:150,-

SMDVUZBR-2



STŮL MYCÍ SE DVĚMA DŘEZY, ZÁSUVKOVÝM BOXEM A ROŠTOVOU POLICÍ (L,P PROVEDENÍ)			
Vnější A x B (mm)	Rozměr dřezu	typ	cena
1400 x 600	400 x 340 x 250	SMDV1	32 200,-
1500 x 600			32 500,-
1600 x 600			32 800,-
1700 x 600			33 100,-
1800 x 600			33 400,-
1400 x 700	400 x 340 x 250	SMDV1	34 600,-
1500 x 700			34 900,-
1600 x 700			35 200,-
1700 x 700			35 500,-
1800 x 700			35 800,-
	500 x 500 x 250	SMDV2	
1600 x 700			39 200,-
1700 x 700			39 600,-
1800 x 700			40 000,-
	500 x 500 x 300	SMDV3	
1600 x 700			41 200,-
1700 x 700			41 600,-
1800 x 700	42 000,-		
1800 x 700	500 x 600 x 350	SMDV4	42 900,-

Otvor pro pákovou baterii: 150,-



STŮL MYCÍ SE DVĚMA DŘEZY, ZÁSUVKOVÝM BOXEM, POLICÍ A POSUVNÝMI DVÍŘKY (L,P PROVEDENÍ)			
Vnější A x B (mm)	Rozměr dřezu	typ	cena
1400 x 600	400 x 340 x 250	SMDV1	37 900,-
1500 x 600			38 300,-
1600 x 600			38 700,-
1700 x 600			39 100,-
1800 x 600			39 500,-
1400 x 700	400 x 340 x 250	SMDV1	38 800,-
1500 x 700			39 200,-
1600 x 700			39 600,-
1700 x 700			40 000,-
1800 x 700			40 400,-
1400 x 700	500 x 500 x 250	SMDV2	39 700,-
1500 x 700			40 100,-
1600 x 700			40 500,-
1700 x 700			40 900,-
1800 x 700			41 300,-
1400 x 700	500 x 500 x 300	SMDV3	39 900,-
1500 x 700			40 300,-
1600 x 700			40 700,-
1700 x 700			41 100,-
1800 x 700			41 500,-
1800 x 700	500 x 600 x 350	SMDV4	42 300,-

Otvor pro pákovou baterii:150,-

SMDVUP-PD



STŮL MYCÍ SE DVĚMA DŘEZY, POLICÍ A POSUVNÝMI SVÍŘKY (L,P PROVEDENÍ)			
Vnější A x B (mm)	Rozměr dřezu	typ	cena
1400 x 600	400 x 400 x 250	SMDV1	37 900,-
1500 x 600			38 300,-
1600 x 600			38 700,-
1700 x 600			39 100,-
1800 x 600			39 500,-
1400 x 700	400 x 400 x 250	SMDV1	38 800,-
1500 x 700			39 200,-
1600 x 700			39 600,-
1700 x 700			40 000,-
1800 x 700			40 400,-
1400 x 700	500 x 500 x 250	SMDV2	39 700,-
1500 x 700			40 100,-
1600 x 700			40 500,-
1700 x 700			40 900,-
1800 x 700			41 300,-
1400 x 700	500 x 500 x 300	SMDV3	39 900,-
1500 x 700			40 300,-
1600 x 700			40 700,-
1700 x 700			41 100,-
1800 x 700			41 500,-
1800 x 700	500 x 600 x 350	SMDV4	42 300,-

Otvor pro pákovou baterii:150,-

VSM1



VSTUPNÍ STŮL K MYČCE SE DŘEZEM 400 x 400 x 250 A OTVOREM PRO TLAKOVOU SPRCHU (L,P PROVEDENÍ)		
Rozměr (mm)		
1200 x 750 x 850	1400 x 750 x 850	1600 x 750 x 850
16 440,-	17 340,-	18 180,-

Otvor pro tlakovou baterii 150,-

Z1



VSTUPNÍ STŮL K MYČCE ZÁVĚSNÝ SE DŘEZEM 400 x 400 x 250 A OTVOREM PRO TLAKOVOU SPRCHU (L,P PROVEDENÍ)

Rozměr (mm)

1200 x 750 x 850

1400 x 750 x 850

1600 x 750 x 850

13 000,-

13 700,-

14 300,-

Otvor pro tlakovou baterii 150,-

VSM2



VÝSTUPNÍ STŮL K MYČCE (L,P PROVEDENÍ)				
Rozměr (mm)				
700x750x850	1000x750x850	1200x750x850	1400x750x850	1600x750x850
10 500,-	12 000,-	13 100,-	14 200,-	15 200,-

Z2



VÝSTUPNÍ STŮL K MYČCE ZÁVĚSNÝ (L,P PROVEDENÍ)				
Rozměr (mm)				
700x750x850	1000x750x850	1200x750x850	1400x750x850	1600x750x850
5 670,-	6 560,-	7 150,-	7 800,-	8 390,-

D



JEDNODŘEZ – LISOVANÝ VEVAŘOVANÝ BEZ POLICE			
Vnější A x B (mm)	Rozměr dřezu	typ	Cena
600 x 600	400 x 400 x 250	D1	9 940,-
700 x 700			10 240,-
600 x 600	450 x 450 x 300	D2	11 620,-
700 x 700			11 920,-
700 x 700	500 x 500 x 250	D3	11 930,-
700 x 700	500 x 500 x 300	D4	12 570,-

Otvor pro pákovou baterii: 150,-



JEDNODŘEZ – LISOVANÝ VEVAŘOVANÝ S POLICÍ			
Vnější A x B (mm)	Rozměr dřezu	typ	Cena
600 x 600	400 x 400 x 250	D1-P	10 950,-
700 x 700			11 460,-
600 x 600	450 x 450 x 250	D2-P	12 740,-
700 x 700			13 340,-
700 x 700	500 x 500 x 250	D3-R	14 110,-
700 x 700	500 x 500 x 300	D4-R	14 730,-

Otvor pro pákovou baterii:150,-



JEDNODŘEZ – LISOVANÝ VEVAŘOVANÝ S ROŠTOVOU POLICÍ			
Vnější A x B (mm)	Rozměr dřezu	typ	Cena
600 x 600	400 x 400 x 250	D1-R	11 300,-
700 x 700			12 100,-
600 x 600	450 x 450 x 250	D2-R	13 150,-
700 x 700			13 990,-
700 x 700	500 x 500 x 250	D3-R	14 740,-
700 x 700	500 x 500 x 300	D4-R	15 380,-

Otvor pro pákovou baterii:150,-

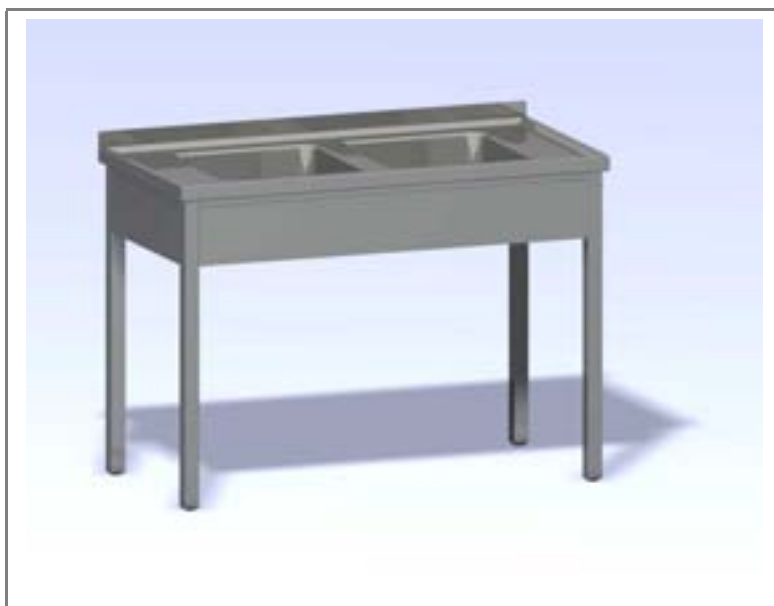

DVOUDŘEZ – LISOVANÝ VEVAŘOVANÝ BEZ POLICE			
Vnější A x B (mm)	Rozměr dřezu	typ	Cena
1000 x 600	400 x 400 x 250	DV1	15 230,-
1100 x 600			15 320,-
1200 x 600			15 470,-
1000 x 700			15 310,-
1100 x 700			15 460,-
1200 x 700			15 670,-
1100 x 600			450 x 450 x 250
1200 x 600	18 350,-		
1100 x 700	18 680,-		
1200 x 700	18 890,-		
700 x 700	500 x 500 x 250	DV3	19 790,-
700 x 700	500 x 500 x 300	DV4	21 490,-

Otvor pro pákovou baterii: 150,-



DVOUDŘEZ – LISOVANÝ VEVAŘOVANÝ S POLICÍ			
Vnější A x B (mm)	Rozměr dřezu	typ	Cena
1000 x 600	400 x 400 x 250	DVP1	16 600,-
1100 x 600			16 860,-
1200 x 600			17 110,-
1000 x 700			16 950,-
1100 x 700			17 200,-
1200 x 700			17 510,-
1100 x 600			450 x 450 x 250
1200 x 600	19 960,-		
1100 x 700	20 410,-		
1200 x 700	21 320,-		
700 x 700	500 x 500 x 250	DVP3	21 500,-
700 x 700	500 x 500 x 300	DVP4	23 320,-

Otvor pro pákovou baterii: 150,-



DVOUDŘEZ – LISOVANÝ VEVAŘOVANÝ S ROŠTOVOU POLICÍ			
Vnější A x B (mm)	Rozměr dřezu	typ	Cena
1000 x 600	400 x 400 x 250	DVR1	16 950,-
1100 x 600			17 220,-
1200 x 600			17 520,-
1000 x 700			17 350,-
1100 x 700			17 640,-
1200 x 700			17 960,-
1100 x 600			450 x 450 x 250
1200 x 600	20 390,-		
1100 x 700	20 860,-		
1200 x 700	21 520,-		
700 x 700	500 x 500 x 250	DVR3	21 960,-
700 x 700	500 x 500 x 300	DVR4	25 610,-

Otvor pro pákovou baterii: 150,-



DŘEZ SVAŘOVANÝ – BEZ POLICE		
A - délka	B - šířka (mm)	
(mm)	600	700
600	9 200,-	9 400,-
700	9 400,-	9 600,-
800	9 600,-	9 800,-
900	9 800,-	10 000,-
1000	10 000,-	10 200,-
1100	10 200,-	10 400,-
1200	10 400,-	10 600,-
1300	10 600,-	10 800,-
1400	10 800,-	11 000,-
1500	11 000,-	11 200,-

Otvor pro pákovou baterii 150,-



DŘEZ SVAŘOVANÝ S POLICÍ		
A – délka	B – šířka (mm)	
(mm)	600	700
600	10 400,-	10 600,-
700	10 600,-	10 800,-
800	10 800,-	11 000,-
900	11 000,-	11 200,-
1000	11 200,-	11 400,-
1100	11 400,-	11 600,-
1200	11 600,-	11 800,-
1300	11 800,-	12 000,-
1400	12 000,-	12 200,-
1500	12 200,-	12 400,-

Otvor pro pákovou baterii 150,-



DŘEZ SVAŘOVANÝ S ROŠTOVOU POLICÍ		
A – délka	B – šířka (mm)	
(mm)	600	700
600	10 600,-	10 800,-
700	10 800,-	11 000,-
800	11 000,-	11 200,-
900	11 200,-	11 400,-
1000	11 400,-	11 600,-
1100	11 600,-	11 800,-
1200	11 800,-	12 000,-
1300	12 000,-	12 200,-
1400	12 200,-	12 400,-
1500	12 400,-	12 600,-

Otvor pro pákovou baterii 150,-



DVOUDŘEZ SVAŘOVANÝ – BEZ POLICE		
A – délka	B – šířka (mm)	
(mm)	600	700
1100	13 300,-	13 500,-
1200	13 500,-	13 700,-
1300	13 700,-	13 900,-
1400	13 900,-	14 100,-
1500	14 100,-	14 300,-
1600	14 300,-	14 500,-
1700	14 500,-	14 700,-

Otvor pro pákovou baterii 150,-



DVOUDŘEZ SVAŘOVANÝ S POLICÍ		
A – délka	B – šířka (mm)	
(mm)	600	700
1100	14 900,-	15 100,-
1200	15 100,-	15 300,-
1300	15 300,-	15 500,-
1400	15 500,-	15 700,-
1500	15 700,-	15 900,-
1600	15 900,-	16 100,-
1700	16 100,-	16 300,-

Otvor pro pákovou baterii 150,-



DVOUDŘEZ SVAŘOVANÝ S ROŠTOVOU POLICÍ		
A – délka	B – šířka (mm)	
(mm)	600	700
1100	15 100,-	15 300,-
1200	15 300,-	15 500,-
1300	15 500,-	15 700,-
1400	15 700,-	15 900,-
1500	15 900,-	16 100,-
1600	16 100,-	16 300,-
1700	16 300,-	16 500,-

Otvor pro pákovou baterii 150,-

DS-V



DŘEZ SVAŘOVANÝ(VELKÝ) – BEZ POLICE		
A – délka	B – šířka (mm)	
(mm)	600	700
1100	10 200,-	10 400,-
1200	10 400,-	10 600,-
1300	10 600,-	10 800,-
1400	10 800,-	11 000,-
1500	11 000,-	11 200,-
1600	11 200,-	11 400,-
1700	11 400,-	11 600,-

Otvor pro pákovou baterii 150,-

DSP-V



DŘEZ SVAŘOVANÝ(VELKÝ) S POLICÍ		
A - délka	B - šířka (mm)	
(mm)	600	700
1100	11 400,-	11 600,-
1200	11 600,-	11 800,-
1300	11 800,-	12 000,-
1400	12 000,-	12 200,-
1500	12 200,-	12 400,-
1600	12 400,-	12 600,-
1700	12 600,-	12 800,-

Otvor pro pákovou baterii: 150,-

DSR-V



DŘEZ SVAŘOVANÝ(VELKÝ) S ROŠTOVOU POLICÍ		
A – délka	B – šířka (mm)	
(mm)	600	700
1100	11 600,-	11 800,-
1200	11 800,-	12 000,-
1300	12 000,-	12 200,-
1400	12 200,-	12 400,-
1500	12 400,-	12 600,-
1600	12 600,-	12 800,-
1700	12 800,-	13 000,-

Otvor pro pákovou baterii: 150,-

VKU20



VÝLEVKA V KOMBINACI S UMYVADLEM
cena
20 930,-

Výlevka je dodávána včetně 2ks baterií a odpad. sifónů.

VKU21



VÝLEVKA
cena
10 350,-

NP1

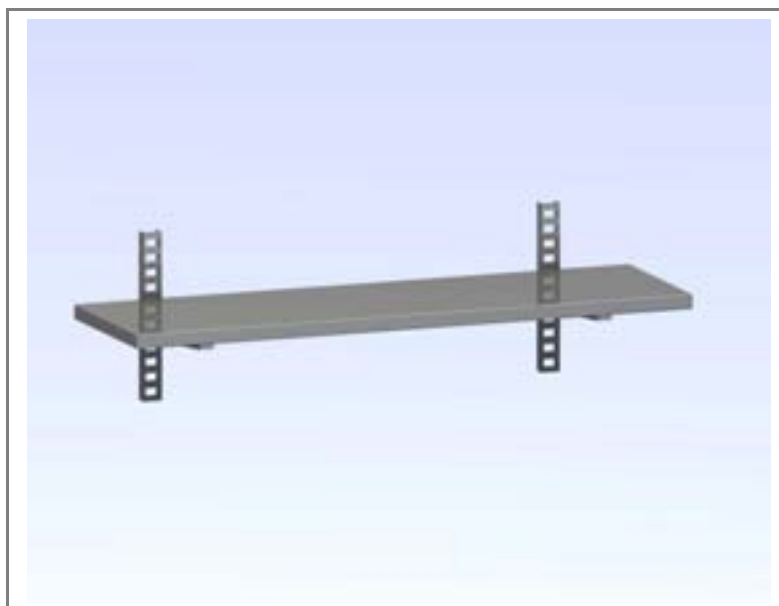

NÁSTĚNNÁ POLICE JEDNOETÁŽOVÁ		
A - délka	B - šířka (mm)	
(mm)	300	350
600	2 200,-	2 280,-
700	2 300,-	2 420,-
800	2 450,-	2 560,-
900	2 600,-	2 700,-
1000	2 700,-	2 840,-
1100	2 860,-	2 980,-
1200	3 000,-	3 120,-
1300	3 110,-	3 260,-
1400	3 250,-	3 400,-
1500	3 380,-	3 540,-
1600	3 510,-	3 680,-
1700	3 640,-	3 820,-
1800	3 770,-	3 960,-
1900	3 900,-	4 100,-
2000	4 020,-	4 270,-

NP2

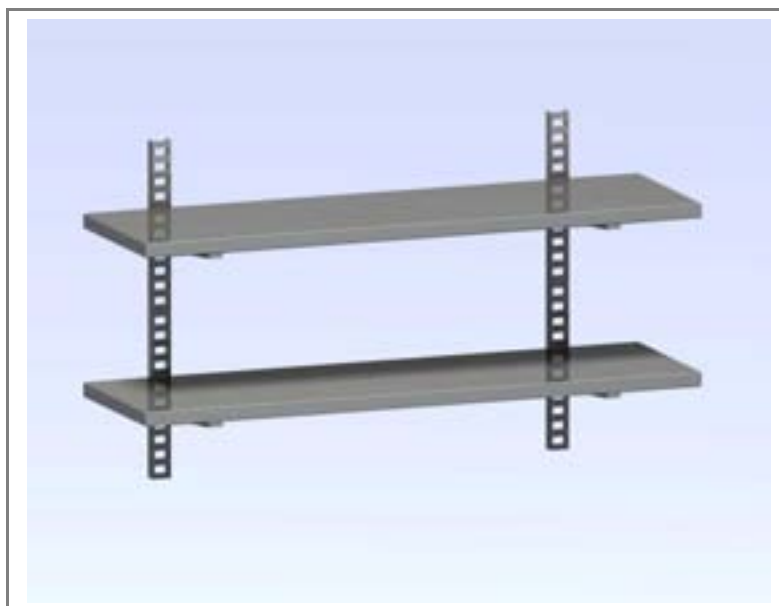

NÁSTĚNNÁ POLICE DVOUETÁŽOVÁ		
A - délka	B - šířka (mm)	
(mm)	300	350
600	4 450,-	4 560,-
700	4 660,-	4 790,-
800	4 870,-	5 020,-
900	5 080,-	5 250,-
1000	5 290,-	5 480,-
1100	5 500,-	5 710,-
1200	5 710,-	5 940,-
1300	5 920,-	6 170,-
1400	6 130,-	6 400,-
1500	6 340,-	6 630,-
1600	6 550,-	6 860,-
1700	6 760,-	7 090,-
1800	6 970,-	7 320,-
1900	7 180,-	7 550,-
2000	7 320,-	7 720,-

NP3

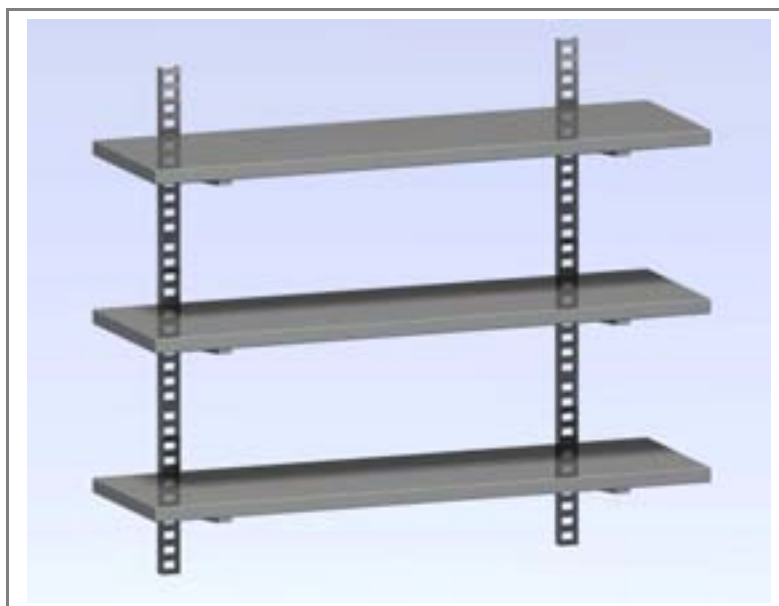

NÁSTĚNNÁ POLICE TŘÍETÁŽOVÁ		
A - délka	B - šířka (mm)	
(mm)	300	350
600	6 700,-	6 800,-
700	6 900,-	7 000,-
800	7 100,-	7 200,-
900	7 300,-	7 400,-
1000	7 500,-	7 600,-
1100	7 700,-	7 800,-
1200	7 900,-	8 000,-
1300	8 100,-	8 200,-
1400	8 300,-	8 400,-
1500	8 500,-	8 600,-
1600	8 700,-	8 800,-
1700	8 900,-	9 000,-
1800	9 100,-	9 200,-
1900	9 300,-	9 400,-
2000	9 500,-	9 600,-

SP1



STOJANOVÁ POLICE JEDNOETÁŽOVÁ		
A - délka	B - šířka (mm)	
(mm)	300	350
600	2 820,-	2 940,-
700	3 000,-	3 090,-
800	3 140,-	3 240,-
900	3 280,-	3 390,-
1000	3 420,-	3 540,-
1100	3 560,-	3 690,-
1200	3 700,-	3 840,-
1300	3 840,-	3 990,-
1400	3 980,-	4 140,-
1500	4 120,-	4 290,-
1600	4 260,-	4 440,-
1700	4 400,-	4 590,-
1800	4 540,-	4 740,-
1900	4 680,-	4 890,-
2000	4 860,-	5 100,-



STOJANOVÁ POLICE DVOUETÁŽOVÁ		
A - délka	B - šířka (mm)	
(mm)	300	350
600	4 200,-	4 340,-
700	4 450,-	4 610,-
800	4 700,-	4 880,-
900	4 950,-	5 150,-
1000	5 200,-	5 420,-
1100	5 450,-	5 690,-
1200	5 700,-	5 960,-
1300	5 950,-	6 230,-
1400	6 200,-	6 500,-
1500	6 450,-	6 770,-
1600	6 700,-	7 040,-
1700	6 950,-	7 310,-
1800	7 200,-	7 580,-
1900	7 450,-	7 850,-
2000	7 680,-	8 140,-

SPU1



STOJANOVÁ POLICE UZAVŘENÁ -JEDNOETÁŽOVÁ		
A - délka	B - šířka (mm)	
(mm)	300	350
600	5 000,-	5 120,-
700	5 100,-	5 220,-
800	5 200,-	5 320,-
900	5 300,-	5 420,-
1000	5 400,-	5 520,-
1100	5 500,-	5 620,-
1200	5 600,-	5 720,-
1300	5 700,-	5 820,-
1400	5 800,-	5 920,-
1500	5 900,-	6 020,-
1600	6 000,-	6 120,-
1700	6 100,-	6 220,-
1800	6 200,-	6 320,-
1900	6 300,-	6 420,-
2000	6 400,-	6 520,-



STOJANOVÁ POLICE UZAVŘENÁ - DVOUETÁŽOVÁ		
A - délka	B - šířka (mm)	
(mm)	300	350
600	6 700,-	6 840,-
700	6 900,-	7 040,-
800	7 100,-	7 240,-
900	7 300,-	7 440,-
1000	7 500,-	7 640,-
1100	7 700,-	7 840,-
1200	7 900,-	8 040,-
1300	8 100,-	8 240,-
1400	8 300,-	8 440,-
1500	8 500,-	8 640,-
1600	8 700,-	8 840,-
1700	8 900,-	9 040,-
1800	9 100,-	9 240,-
1900	9 300,-	9 440,-
2000	9 500,-	9 640,-

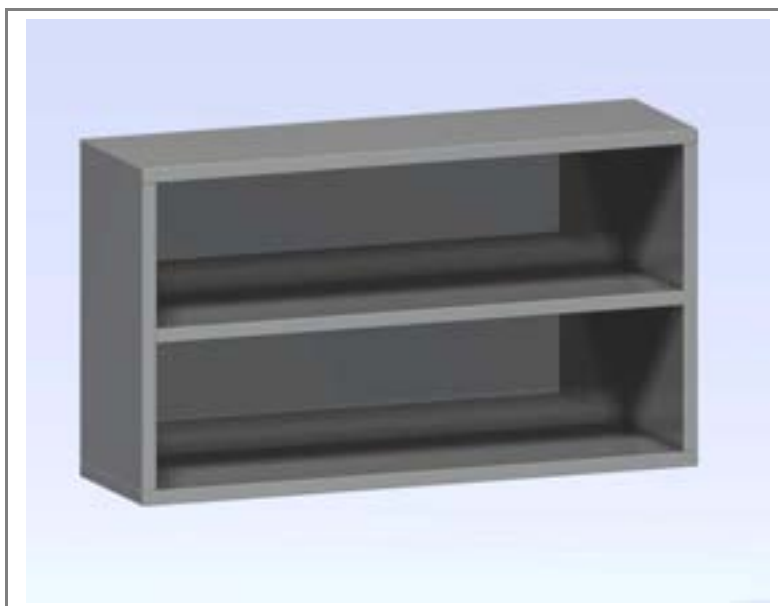

SKŘÍŇKA NÁSTĚNNÁ S PŘESTAVITELNOU POLICÍ	
A - délka	šířka 350 mm
(mm)	
600	8 900,-
700	9 500,-
800	10 200,-
900	10 800,-
1000	11 450,-
1100	12 180,-
1200	12 700,-
1300	13 320,-
1400	13 950,-
1500	14 600,-
1600	15 210,-
1700	15 850,-
1800	16 500,-
1900	17 100,-
2000	17 720,-

SNP-PD

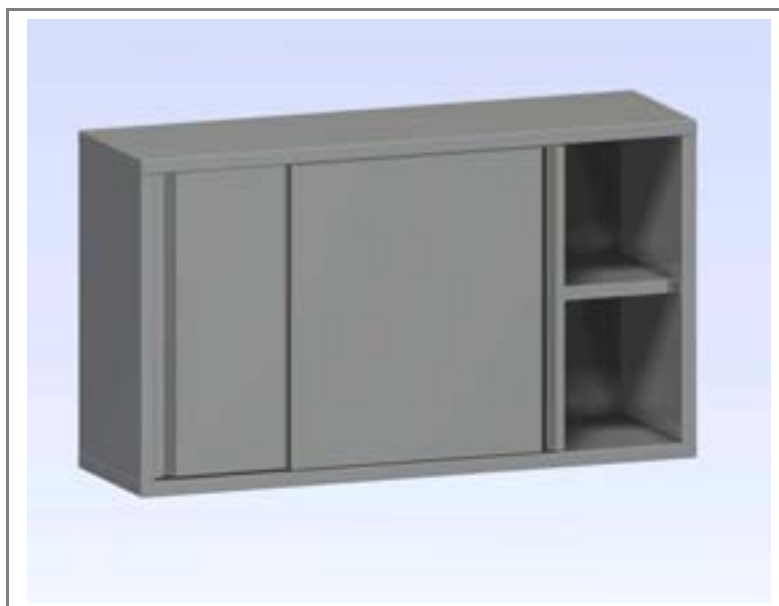

SKŘÍŇKA NÁSTĚNNÁ S POSUVNÝMI DVÍŘKY A PŘESTAVITELNOU POLICÍ	
A - délka	šířka 350 mm
(mm)	
1000	14 200,-
1100	14 820,-
1200	15 440,-
1300	16 080,-
1400	16 680,-
1500	17 300,-
1600	17 920,-
1700	18 540,-
1800	19 160,-
1900	19 780,-
2000	20 400,-

SNP-KD

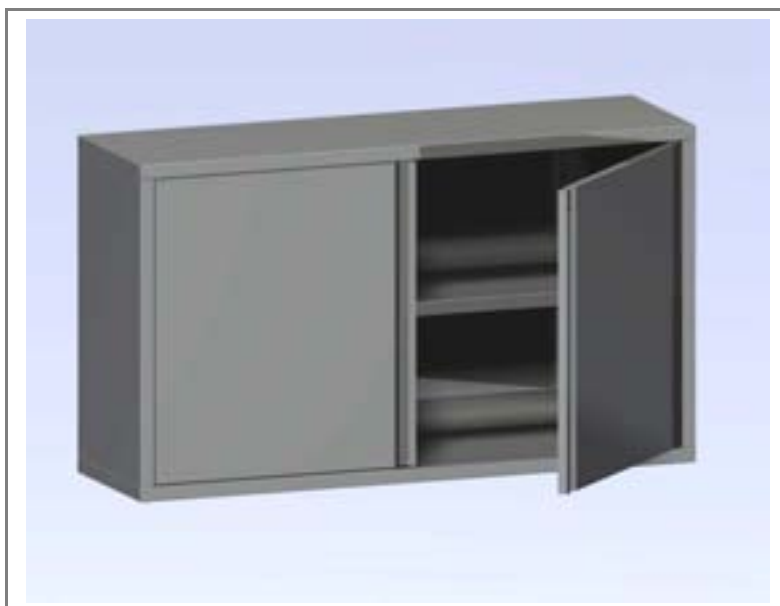

SKŘÍŇKA NÁSTĚNNÁ S KŘÍDLOVÝMI DVÍŘKY A PŘESTAVITELNOU POLICÍ	
A - délka	šířka 350 mm
(mm)	
1000	14 200,-
1100	14 820,-
1200	15 440,-
1300	16 080,-
1400	16 680,-
1500	17 300,-
1600	17 920,-
1700	18 540,-
1800	19 160,-
1900	19 780,-
2000	20 400,-



UZAVÍRATELNÁ PŘÍBORNÍKOVÁ SKŘÍŇ S PŘESTAVITELNOU POLICÍ A POSUVNÝMI DVÍŘKY

A - délka (mm)	B - šířka (mm)		
	600	700	800
1000	31 840,-	36 420,-	37 880,-
1100	33 630,-	37 960,-	39 610,-
1200	35 510,-	39 700,-	41 420,-
1300	37 220,-	41 500,-	43 190,-
1400	39 000,-	42 980,-	44 900,-
1500	40 790,-	44 610,-	46 730,-
1600	42 580,-	46 250,-	48 500,-
1700	44 320,-	47 900,-	50 270,-
1800	46 150,-	49 460,-	51 990,-
1900	47 950,-	51 180,-	53 810,-
2000	49 760,-	52 770,-	55 530,-

Příplatek za atypické provedení

Uzamykání dvířek: 900,-

Dveře z obou stran: 12%



UZAVÍRATELNÁ PŘÍBORNÍKOVÁ SKŘÍŇ S PŘESTAVITELNOU POLICÍ A KŘÍDLOVÝMI
DVÍŘKY

A - délka (mm)	B - šířka (mm)		
	600	700	800
1000	31 840,-	36 420,-	37 880,-
1100	33 630,-	37 960,-	39 610,-
1200	35 510,-	39 700,-	41 420,-
1300	37 220,-	41 500,-	43 190,-
1400	39 000,-	42 980,-	44 900,-
1500	40 790,-	44 610,-	46 730,-
1600	42 580,-	46 250,-	48 500,-
1700	44 320,-	47 900,-	50 270,-
1800	46 150,-	49 460,-	51 990,-
1900	47 950,-	51 180,-	53 810,-
2000	49 760,-	52 770,-	55 530,-

Příplatek za atypické provedení

Uzamykání dvířek: 900,-

Dveře z obou stran: 12%



MANIPULAČNÍ VOŽÍK NA PLATA A PŘÍBORY	
Rozměr (mm)	Cena
800 x 500 x 1250	13 950,-
900 x 600 x 1250	14 830,-



MANIPULAČNÍ VOŽÍK NA ZÁSOBNÍK ČAJE NEBO KÁVY S JEDNOU POLICÍ A
ODKAPÁVAČEM

Rozměr (mm)	Cena
800 x 500 x 850	10 950,-
800 x 600 x 850	11 550,-

VOS1



VOZÍK SERVÍROVACÍ	
Délka x šířka (mm)	Cena
800 x 500	7 920,-
900 x 500	8 150,-
1000 x 500	8 380,-

800 x 600	8 210,-
900 x 600	8 650,-
1000 x 600	9 090,-

VOS2



VOZÍK SERvíROVACÍ PATROVÝ

Délka x šířka (mm)	Cena
800 x 500	9 940,-
900 x 500	10 060,-
1000 x 500	10 180,-

800 x 600	10 620,-
900 x 600	10 990,-
1000 x 600	11 360,-



VOZÍK PLOŠINOVÝ		
A - délka	B - šířka (mm)	
(mm)	500	600
800	7 900,-	8 200,-
900	8 130,-	8 400,-
1000	8 360,-	8 600,-
1100	8 590,-	8 800,-
1200	8 820,-	9 000,-



MANIPULAČNÍ VOŽÍK NA GASTRO NÁDOBY S PRACOVNÍ PLOCHOU (L.P. PROVEDENÍ)		
A - délka (mm)	B - šířka (mm)	
	600	700
800	13 900,-	14 200,-

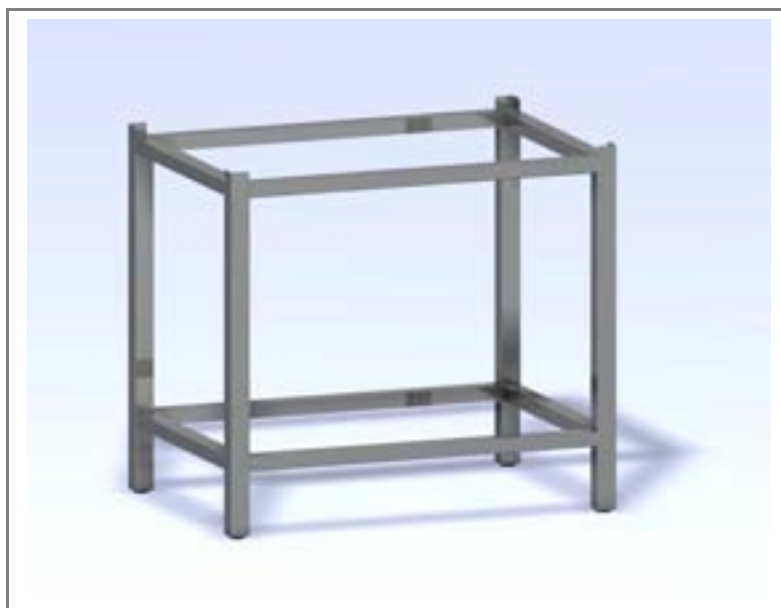

JEDNODŘEZ – LISOVANÝ VEVAŘOVANÝ BEZ POLICE			
Typ	Rozměr A x B (mm)	Počet zásuvů	Cena
GN 1/1	390 x 530	15	9 195,-
GN 1/2	595 x 650	15	11 356,-

PK

PODESTAVBA POD KONVEKTOMAT				
Typ	Výška (mm)	Délka (mm)	Hloubka	Cena
6 GN 1/1	770	865	755	4 100,-
10 GN 1/1	700	810	640	4 700,-
20 GN 1/1	700	870	840	4 900,-

PK1

PODESTAVBA POD KONVEKTOMAT				
Typ	Výška (mm)	Délka (mm)	Hloubka	Cena
6 GN 1/1	770	865	755	5 300,-
10 GN 1/1	700	810	640	5 900,-
20 GN 1/1	700	870	840	6 125,-

PK2-P

PODESTAVBA POD KONVEKTOMAT SE ZÁSUVY PRO GN				
Typ	Výška (mm)	Délka (mm)	Hloubka	Cena
6 GN 1/1	770	865	755	8 500,-
10 GN 1/1	700	810	640	9 000,-
20 GN 1/1	700	870	840	9 300,-

PK3-P

PODESTAVBA POD KONVEKTOMAT SE ZÁSUVY PRO GN (OBOUSTRANÝ)				
Typ	Výška (mm)	Délka (mm)	Hloubka	Cena
6 GN 1/1	770	865	755	10 000,-
10 GN 1/1	700	810	640	10 500,-
20 GN 1/1	700	870	840	10 800,-

RP4/RP5



REGÁL POLICOVÝ – S PLNÝMI POLICEMI						
Délka	Šířka 400 (mm)		Šířka 500 (mm)		Šířka 600 (mm)	
	4 polic	5 polic	4 polic	5 polic	4 polic	5 polic
500	8 400,-	9 400,-	8 640,-	9 860,-	8 930,-	10 220,-
600	8 800,-	9 930,-	9 130,-	10 460,-	9 480,-	10 910,-
700	9 200,-	10 460,-	9 620,-	11 070,-	10 030,-	11 600,-
800	9 600,-	10 990,-	10 110,-	11 680,-	10 580,-	12 290,-
900	10 000,-	11 520,-	10 600,-	12 290,-	11 130,-	12 980,-
1000	10 400,-	12 050,-	11 090,-	12 900,-	11 620,-	13 670,-
1100	10 800,-	12 580,-	11 580,-	13 510,-	12 230,-	14 360,-
1200	11 200,-	13 110,-	12 070,-	14 120,-	12 780,-	15 050,-
1300	11 600,-	13 640,-	12 560,-	14 730,-	13 330,-	15 740,-
1400	12 000,-	14 170,-	13 050,-	15 340,-	13 880,-	16 430,-
1500	14 400,-	14 700,-	13 540,-	15 950,-	14 430,-	17 120,-
1600	12 800,-	15 230,-	14 030,-	16 560,-	14 980,-	17 810,-
1700	13 200,-	15 760,-	14 520,-	17 170,-	15 530,-	18 500,-
1800	13 600,-	16 280,-	14 990,-	17 770,-	16 130,-	19 220,-

RR4/RR5



REGÁL POLICOVÝ – S ROŠTOVÝMI POLICEMI						
Délka	Šířka 400 (mm)		Šířka 500 (mm)		Šířka 600 (mm)	
	4 polic	5 polic	4 polic	5 polic	4 polic	5 polic
500	11 300,-	12 300,-	11 500,-	12 700,-	11 800,-	13 100,-
600	11 700,-	12 800,-	12 000,-	13 300,-	12 400,-	13 800,-
700	12 100,-	13 300,-	12 500,-	13 900,-	13 000,-	14 500,-
800	12 500,-	13 800,-	13 000,-	14 500,-	13 600,-	15 200,-
900	12 900,-	14 300,-	13 500,-	15 100,-	14 200,-	15 900,-
1000	13 300,-	14 800,-	14 000,-	15 700,-	14 800,-	16 600,-
1100	13 700,-	15 300,-	14 500,-	16 300,-	15 400,-	17 300,-
1200	14 100,-	15 800,-	15 000,-	16 900,-	16 000,-	18 000,-
1300	14 500,-	16 300,-	15 500,-	17 500,-	16 600,-	18 700,-
1400	14 900,-	16 800,-	16 000,-	18 100,-	17 200,-	19 400,-
1500	15 300,-	17 300,-	16 500,-	18 700,-	17 800,-	20 100,-
1600	15 700,-	17 800,-	17 000,-	19 300,-	18 400,-	20 800,-
1700	16 100,-	18 300,-	17 500,-	19 900,-	19 000,-	21 500,-
1800	16 500,-	18 800,-	18 000,-	20 500,-	19 600,-	22 200,-



REGÁL NA UKLÁDÁNÍ GASTRONÁDOB A PEČÍCÍCH PLECHŮ			
Výška (mm)	GN 1/1	GN 2/1	Počet zásuvů
	395 x 535	600 x 655	
850	5 240,-	5 646,-	8
1200	5 774,-	6 180,-	12
1600	6 300,-	6 500,-	16
1800	6 600,-	6 858,-	18
2000	6 900,-	7 106,-	20

NOP-1



ODŠAVAČ PAR				
Délka (mm)	Hloubka (mm)			Počet filtrů
	700	800	1000	
600	10 040,-	10 420,-	11 100,-	1
700	11 890,-	12 360,-	13 190,-	2
800	13 740,-	14 300,-	15 280,-	2
900	15 590,-	16 240,-	17 370,-	2
1000	17 440,-	18 180,-	19 460,-	2
1200	19 290,-	20 120,-	21 550,-	2
1400	21 140,-	22 060,-	23 640,-	3
1600	22 990,-	24 000,-	25 730,-	3
1800	24 840,-	25 940,-	27 820,-	3
2000	26 690,-	27 880,-	29 910,-	3
2200	28 540,-	29 820,-	32 000,-	3
2400	30 390,-	31 760,-	34 090,-	4
2600	32 240,-	33 700,-	36 180,-	4
2800	34 090,-	35 640,-	38 270,-	4
3000	35 940,-	37 580,-	40 360,-	5
3200	37 790,-	39 520,-	42 450,-	5
3400	39 640,-	41 460,-	44 540,-	6
3600	41 490,-	43 400,-	46 630,-	6
3800	43 340,-	45 340,-	48 720,-	7
4000	45 190,-	47 280,-	50 810,-	7

NOP-2

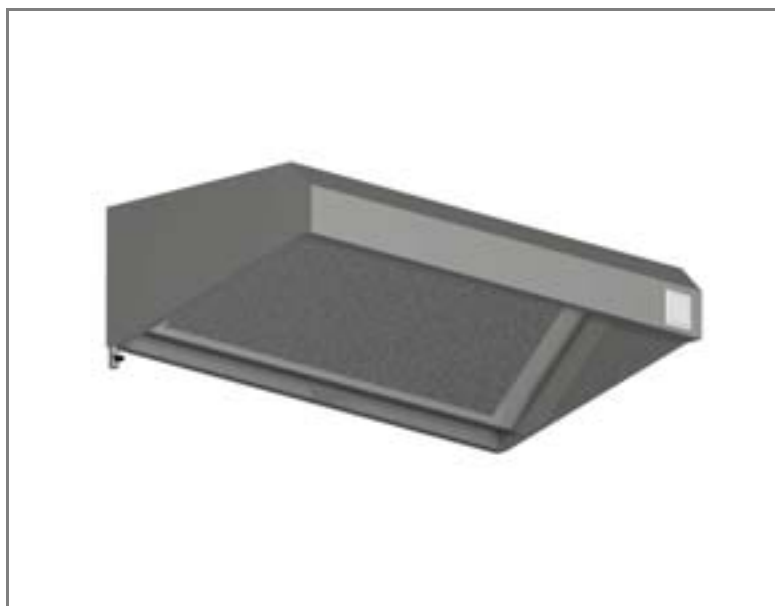

ODŠAVAČ PAR				
Délka (mm)	Hloubka (mm)			Počet filtrů
	700	800	1000	
600	9 890,-	10 180,-	10 790,-	1
700	11 530,-	11 870,-	12 590,-	2
800	13 170,-	13 560,-	14 390,-	2
900	14 810,-	15 250,-	16 190,-	2
1000	16 450,-	16 940,-	17 990,-	2
1200	18 090,-	18 630,-	19 790,-	2
1400	19 730,-	20 320,-	21 590,-	3
1600	21 370,-	22 010,-	23 390,-	3
1800	23 010,-	23 700,-	25 190,-	3
2000	24 650,-	25 390,-	26 990,-	3
2200	26 290,-	27 080,-	28 790,-	3
2400	27 930,-	28 770,-	30 590,-	4
2600	29 570,-	30 460,-	32 390,-	4
2800	31 210,-	32 150,-	34 190,-	4
3000	32 850,-	33 840,-	35 990,-	5
3200	34 490,-	35 530,-	37 790,-	5
3400	36 130,-	37 220,-	39 590,-	6
3600	37 770,-	38 910,-	41 390,-	6
3800	39 410,-	40 600,-	43 190,-	7
4000	41 050,-	42 290,-	46 990,-	7

ZOP-1



ODŠAVAČ PAR				
Délka (mm)	Hloubka (mm)			Počet filtrů
	700	800	1000	
600	12 180,-	12 670,-	14 490,-	1
700	14 290,-	14 820,-	16 670,-	2
800	16 400,-	16 970,-	18 850,-	2
900	18 510,-	19 120,-	21 030,-	2
1000	20 620,-	21 270,-	23 510,-	2
1200	22 730,-	23 420,-	25 390,-	2
1400	24 840,-	25 570,-	27 570,-	3
1600	26 950,-	27 720,-	29 750,-	3
1800	29 060,-	29 870,-	31 930,-	3
2000	31 170,-	32 020,-	34 110,-	3
2200	33 280,-	34 170,-	36 290,-	3
2400	35 390,-	36 320,-	38 470,-	4
2600	37 500,-	38 470,-	40 650,-	4
2800	39 610,-	40 620,-	42 830,-	4
3000	41 720,-	42 770,-	45 010,-	5
3200	43 830,-	44 920,-	47 190,-	5
3400	45 940,-	47 070,-	49 370,-	6
3600	48 050,-	49 220,-	51 550,-	6
3800	50 120,-	51 370,-	53 730,-	7
4000	52 270,-	53 520,-	55 910,-	7

ZOP-2



ODSAVAČ PAR					
Délka (mm)	Hloubka (mm)				Počet filtrů
	1600	1800	2000	2200	
600	16 940,-	17 530,-	18 120,-	18 620,-	1
700	19 790,-	20 470,-	21 150,-	21 740,-	2
800	22 640,-	23 410,-	20 480,-	24 860,-	2
900	25 490,-	26 350,-	27 210,-	27 980,-	2
1000	28 340,-	29 290,-	30 240,-	31 100,-	2
1200	31 190,-	32 230,-	33 270,-	34 220,-	2
1400	34 040,-	35 170,-	36 300,-	37 340,-	3
1600	36 890,-	38 110,-	39 330,-	40 460,-	6
1800	39 740,-	41 050,-	42 360,-	43 580,-	6
2000	42 590,-	43 990,-	45 390,-	46 700,-	6
2200	45 440,-	46 930,-	48 420,-	49 820,-	6
2400	48 290,-	49 870,-	51 450,-	52 940,-	6
2600	51 140,-	52 810,-	54 480,-	56 060,-	8
2800	53 990,-	55 750,-	57 510,-	59 180,-	8
3000	56 840,-	58 690,-	60 540,-	62 300,-	10
3200	59 690,-	61 630,-	63 570,-	65 420,-	10
3400	62 540,-	64 570,-	66 600,-	68 540,-	12
3600	65 390,-	67 510,-	69 630,-	71 660,-	12
3800	68 240,-	70 450,-	72 660,-	74 780,-	12
4000	71 090,-	73 390,-	75 690,-	77 900,-	12



DRÁHA NA PODNOSY - TRUBKOVÁ
cena
3 120,- / m – včetně konzolí

DPJ



DRÁHA NA PODNOSY - JEKLOVÁ
cena
2 380,- / m – včetně konzolí

ZGN-U



ZÁSOBNÍK NA GASTRONÁDOBY UZAVŘENÝ OTEVŘENÝ GN1/4 -150		
Rozměr	Počet GN	Cena
460x330x250 mm	2	3 420,-
630x330x250 mm	3	3 920,-
800x330x250 mm	4	4 420,-
960x330x250 mm	5	4 920,-

ZGN-O



ZÁSOBNÍK NA GASTRONÁDOBY OTEVŘENÝ GN1/4 -150		
Rozměr	Počet GN	Cena
370x308x400 mm	2	3 130,-
540x308x400 mm	3	3 430,-
704x308x400 mm	4	3 730,-
870x308x400 mm	5	4 030,-

PODLAHOVÝ ROŠT S VPUSTÍ ***PRV***

124

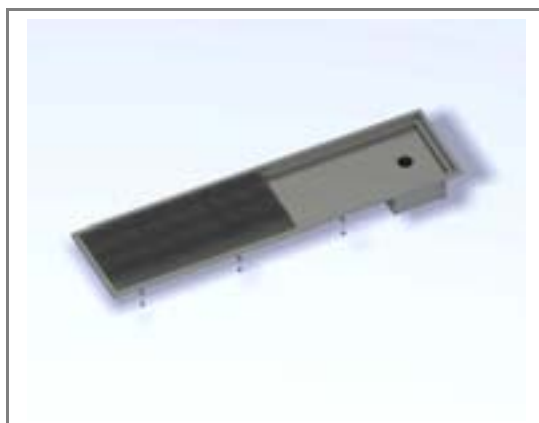

PODLAHOVÝ ROŠT S VPUSTÍ			
A - délka (mm)	B - šířka (mm)		
	300	400	500
1000	9 900,-	10 700,-	11 500,-
2000	12 700,-	14 300,-	15 800,-
3000	16 000,-	18 300,-	20 600,-
4000	19 800,-	22 900,-	26 600,-

VD

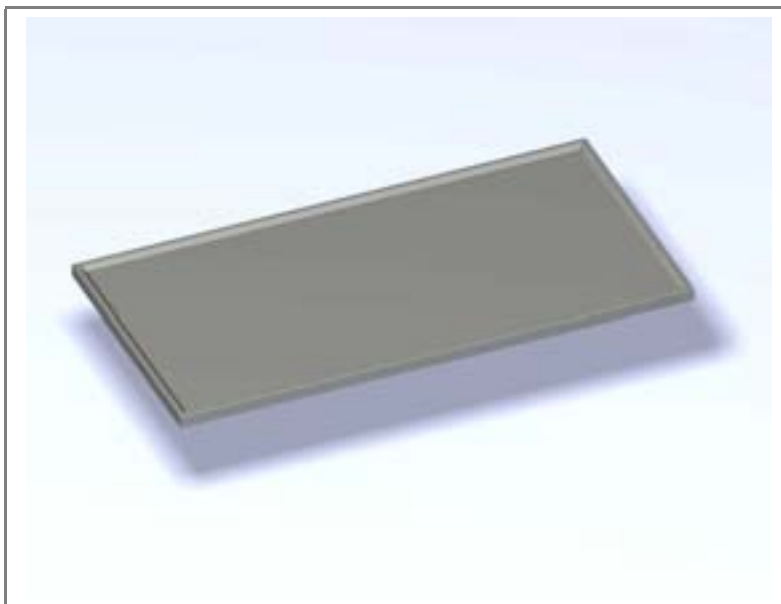

VÝČEPNÍ DESKA			
A - délka (mm)	B - šířka (mm)		
	600	700	800
600	3 010,-	3 130,-	3 260,-
700	3 190,-	3 330,-	3 470,-
800	3 360,-	3 520,-	3 680,-
900	3 540,-	3 720,-	3 890,-
1000	3 710,-	3 910,-	4 100,-
1100	3 890,-	4 100,-	4 300,-
1200	4 060,-	4 290,-	4 510,-
1300	4 230,-	4 480,-	4 710,-
1400	4 410,-	4 690,-	4 940,-
1500	4 580,-	4 870,-	5 150,-
1600	4 760,-	5 060,-	5 360,-
1700	4 940,-	5 250,-	5 570,-
1800	5 110,-	5 450,-	5 780,-
1900	5 290,-	5 640,-	5 990,-
2000	5 460,-	5 830,-	6 200,-
2100	5 640,-	6 030,-	6 420,-
2200	5 820,-	6 220,-	6 630,-
2300	5 980,-	6 410,-	6 830,-
2400	6 160,-	6 600,-	7 040,-
2500	6 340,-	6 790,-	7 250,-
2600	6 510,-	6 990,-	7 460,-
2700	6 690,-	7 180,-	7 670,-
2800	6 860,-	7 370,-	7 880,-



Rozměr (mm)	cena
340 x 400 x 250 / L,P	4 580,-



Rozměr (mm)	cena
400 x 400 x 250 / L,P	5 020,-



Rozměr (mm)	cena
400 x 500 x 250 / L,P	5 460,-



Rozměr (mm)	cena
450 x 450 x 250 / L,P	5 460,-



SVÁŘENÝ DŘEZ	
Rozměr (mm)	cena
420 x 220 x 330 / L,P	3 900,-

VEVAŘENÍ GN DŘEZŮ A ODKAPŮ 127



Název	Rozměr (mm)	cena
GN 2/3 - 200	352 x 325 x 200	3 520,-



Název	Rozměr (mm)	cena
GN 1/2 - 200	325 x 265 x 200	2 990,-



Název	Rozměr (mm)	cena
ODKAP - 8	800 x 200 x 20	2 700,-



Název	Rozměr (mm)	cena
ODKAP - 6	600 x 200 x 20	2 500,-



Název	Rozměr (mm)	cena
ODKAP - 4	400 x 200 x 20	2 300,-



Název	Rozměr (mm)	cena
ODKAP - P/8	800 x 200 x 20	2 000,-



Název	Rozměr (mm)	cena
ODKAP - P/6	600 x 200 x 20	1 900,-



Název	Rozměr (mm)	cena
ODKAP - P/4	400 x 200 x 20	1 800,-

STŮL CHLADÍCÍ DVOUDVĚŘOVÝ 129

STŮL CHLADÍCÍ DVOUDVĚŘOVÝ

Celonerezové provedení

Pro uložení GN 1/1

Nucená cirkulace vzduchu

Provozní teplota -2 °C/ + 8 °C

Chladicí agregát vpravo

Horní deska bez zadního lemu

1420 x 700 x 900 v



43 890,-

PŘÍSLUŠENSTVÍ - STŮL CHLADÍCÍ DVOUDVĚŘOVÝ

DESKA HORNÍ S LEMEM

Provedení desky s horním lemem na objednávku.



DESKA HORNÍ GRANITOVÁ

Příplatek za provedení desky s granitem.



7 690,-

ZÁSUVKOVÝ SET

2 x zásuvka (1/2+1/2)
Příplatek za zásuvky



10 990,-

ZÁSUVKOVÝ SET

2 x zásuvka (1/3+2/3)
Příplatek za zásuvky



10 990,-

ZÁSUVKOVÝ SET

3 x zásuvka (1/3+1/3+1/3)
Příplatek za zásuvky



12 990,-

ZAMYKÁNÍ CHLAZENÉHO STOLU

1 560,-

STŮL CHLADÍCÍ TŘÍDVEŘOVÝ

Celonerezové provedení

Pro uložení GN 1/1

Nucená cirkulace vzduchu

Provozní teplota -2 °C/ + 8 °C

Chladicí agregát vpravo

Horní deska bez zadního lemu

1870 x 700 x 900 v



51 990,-

PŘÍSLUŠENSTVÍ - STŮL CHLADÍCÍ TŘÍDVEŘOVÝ

DESKA HORNÍ S LEMEM

Provedení desky s horním lemem na objednávku.



DESKA HORNÍ GRANITOVÁ

Příplatek za provedení desky s granitem.



9 850,-

ZÁSUVKOVÝ SET

2 x zásuvka (1/2+1/2)
Příplatek za zásuvky



10 990,-

ZÁSUVKOVÝ SET

2 x zásuvka (1/3+2/3)
Příplatek za zásuvky



10 990,-

ZÁSUVKOVÝ SET

3 x zásuvka (1/3+1/3+1/3)
Příplatek za zásuvky



12 990,-

ZAMYKÁNÍ CHLAZENÉHO STOLU

2 390,-

STŮL CHLADÍCÍ ČTYŘDVEŘOVÝ 131

STŮL CHLADÍCÍ ČTYŘDVEŘOVÝ

Celonerezové provedení

Pro uložení GN 1/1

Nucená cirkulace vzduchu

Provozní teplota -2 °C/ + 8 °C

Chladicí agregát vpravo

Horní deska bez zadního lemu

2320 x 700 x 900 v



59 900,-

PŘÍSLUŠENSTVÍ - STŮL CHLADÍCÍ ČTYŘDVEŘOVÝ

DESKA HORNÍ S LEMEM

Provedení desky s horním lemem na objednávku.



DESKA HORNÍ GRANITOVÁ

Příplatek za provedení desky s granitem.



11 990,-

ZÁSUVKOVÝ SET

2 x zásuvka (1/2+1/2)
Příplatek za zásuvky

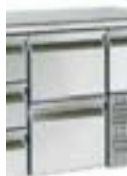

10 990,-

ZÁSUVKOVÝ SET

2 x zásuvka (1/3+2/3)
Příplatek za zásuvky



10 990,-

ZÁSUVKOVÝ SET

3 x zásuvka (1/3+1/3+1/3)
Příplatek za zásuvky



12 990,-

ZAMYKÁNÍ CHLAZENÉHO STOLU

3 100,-